

**EGAN**

**2023**

# Price & Specification Guide

USA PSG

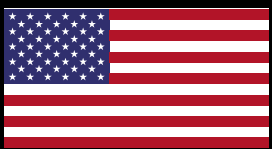



The Egan QuickShip list is a collection of Egan's most popular products and sizes that can be shipped within 5 business days of receiving an order\*.

**The Aluminum Frame Markerboard** is a classic. Our proprietary dry-erase surface, EVS, is a commercial grade surface that can withstand the toughest environments and is guaranteed-to-clean. With a magnetic backer infill, the Aluminum Frame markerboard is magnet compatible with a clear anodized aluminum frame, precision squared mitered corners and will never warp.

**Dimension 13** is an elevated design on the traditional markerboard. Fully wrapped in EVS, Dimension 13 is a 1/2" (13mm) frameless board that beautifully blends into your environment; designed specifically for free flow thinking, with clean lines to keep the mind clear and free from distraction.

**GlassWrite** is a backpainted white, frameless glass board. Egan uses high quality, tempered safety glass that has no tint and will not distort the color of your board. Cleat mounted and neo-magnetic compatible. GlassWrite non-magnetic boards also available in white only.

**V-Series Mobile** features EVS dry-erase surface on both sides that accepts magnetic accessories. The V-Series frame is defined by robust, clear anodized aluminum.

	V-Series Mobile	Dimension 13	GlassWrite MAG	GlassWrite Non-magnetic	Aluminum Frame Markerboard
48"w x 48"h	-	\$1,310	\$1,840	\$1,510	\$730
60"w x 48"h	-	\$1,430	\$2,120	\$1,570	\$860
72"w x 48"h	-	\$1,510	\$2,520	\$1,980	\$980
96"w x 48"h	-	\$1,700	\$3,100	\$2,350	\$1,170
48"w x 72"h	2,020	-	-	-	-

Code	Product	Surface	Frame/Edge	Mount
DM13	Dimension 13	EVS	White	Wall
DGM	GlassWrite MAG	White	Frameless	Wall
DG	GlassWrite	White	Frameless	Wall
MES	Aluminum Frame Markerboard	EVS	Clear Anodized	Wall
VSF	V-Series Mobile	EVS both sides	Clear Anodized	Mobile

## ACCESSORIES

**EganONE Tray**, a sleek, aluminum marker tray that comes in a 2" deep design to accommodate 2 rows of markers, and provides an attachment point for the new Egan Cloth.

Code	Dimensions	Price
ACEOT12M (Magnetic Mount)	12"w x 1-3/8"h x 2"d	\$150
ACEOT12A (Adhesive Mount)	12"w x 1-3/8"h x 2"d	\$150

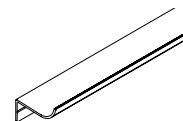

## HOW TO ORDER

**DM13 60 48 WH**

Product Code    Width    Height    Edge Color

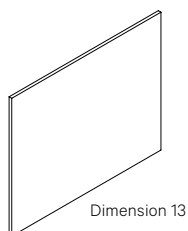

**DGM 48 48 C**

Product Code    Width    Height    Cleat Mount

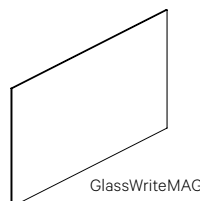

**MES 96 48 W**

Product Code    Width    Height    Wallmount

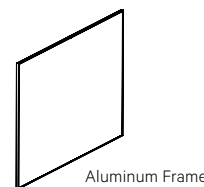

**VSF 48 72**

Product Code    Width    Height

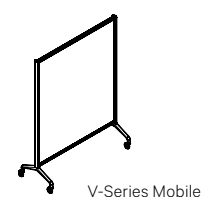

\*Orders exceeding six (6) units per product are subject to longer lead times



Egan Versa Presentation Surface (EVS™) is an Egan exclusive patented-technology presentation surface introduced in 2002. It is a unique invention that distinguishes Egan products from the rest in the presentation furniture industry. EVS has inspired the creation of various whiteboard and projection screen product offerings. It is the unique tool for generating, capturing and presenting ideas. This technology surface enhances communication by supporting whiteboard brainstorming as well as data projection of popular presentation formats.

The matte-white finish reduces glare from ambient light in office environments. Glare can cause a reduction in character-to-background contrast, reducing the legibility of screen characters, which at the extreme can cause the contents of the whiteboard to become unrecognizable. Because this only affects viewing at eye level and from only parts of the room, many whiteboard users are not even aware of this major shortcoming! To overcome glare, whiteboard readers will often squint or move about to minimize the effect. EVS solves that problem.

EVS provides a matte-white surface with an incredibly low-gloss factor that is guaranteed-to-clean. The unique surface provides a comfortable 160° viewing angle of your projected image. That means you get a crisp, clear view from almost any angle in the room, without dimming the lights.

When mounted on steel, EVS accepts magnetic accessories.

Versatility is also found in EVS' configurability. EVS is available in a variety of large and small format applications, can be applied on almost any even surface, and can be specified in a variety of sizes and shapes. Apply EganINK™ graphics, and let the sky be your limit! EVS is guaranteed-to-clean for 10 years.



White Porcelain

Porcelain

Dry-Erase Vinyl

EVS

Above images illustrate the difference in surface glare on leading whiteboards

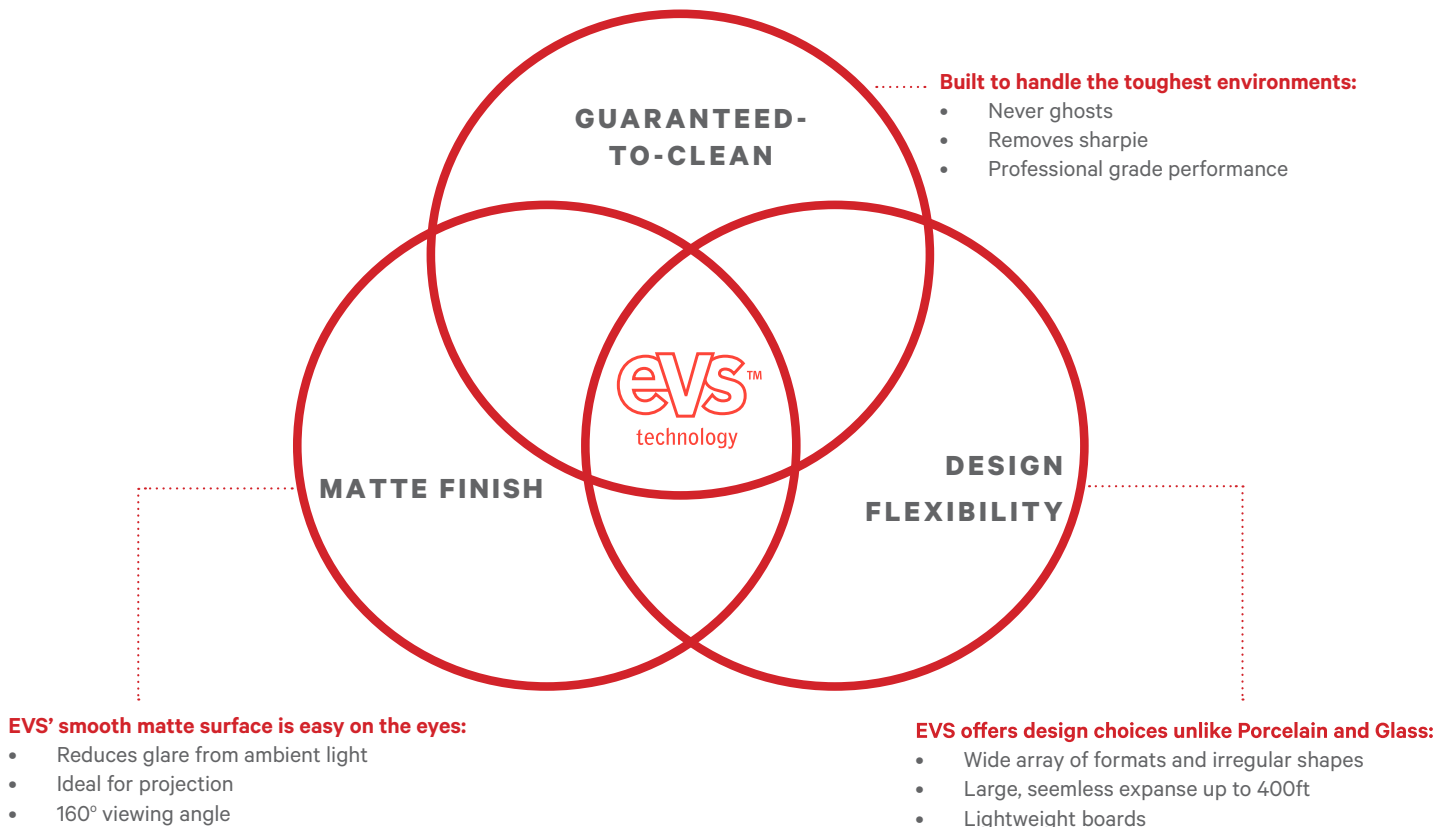

# Need Info Now?



## Speak with a live Customer Service Rep

1-800-263-2387

+1-905-851-2826

Live coverage Mon-Fri 8:00-4:30 EST



## Speak with your local Egan Manufacturer's Rep

Egan Visual has a network of professional sales representatives covering every major market in the US and Canada.

Visit <https://egan.com/rep-locator/> or contact Egan Customer Service and we will be happy to connect you directly.



## Email a Customer Service Rep or Sales Team Member

[customerservice@egan.com](mailto:customerservice@egan.com)

[sales@egan.com](mailto:sales@egan.com)



## Receive Egan Updates

Subscribe to Egan News & Product Bulletins: email "Subscribe" to [marketing@egan.com](mailto:marketing@egan.com)



## Egan Website

[www.egan.com](http://www.egan.com)

Retrieve complete and up-to-date information online:

- Latest Specifications
- New Features
- What's New
- Resources: Installation Guides, LEED Data Sheets, GREENGUARD® Certificates, Videos

## Connect with Egan



### Browse galleries, images and virtual showrooms

[www.pinterest.com/eganvisual](http://www.pinterest.com/eganvisual)



### Be a friend of Egan on Facebook

[www.facebook.com/egan.visual](http://www.facebook.com/egan.visual)



### Watch videos on YouTube

[www.youtube.com/eganvisual](http://www.youtube.com/eganvisual)



### Follow Egan on Instagram

[@eganvisual](https://www.instagram.com/eganvisual)



### Connect with Egan on LinkedIn

[www.linkedin.com/company/egan-visual](http://www.linkedin.com/company/egan-visual)

## Additional Online Industry Presence

[myresourcelibrary.com](http://myresourcelibrary.com)



[2020spaces.com](http://2020spaces.com)



[projectmatrix.com](http://projectmatrix.com)

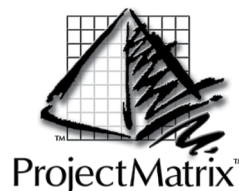

[gsaadvantage.gov](http://gsaadvantage.gov)



## Contracts and Buying Groups



### Government Contracts

Egan is participating as a vendor on many government procurement contracts and market-specific buying groups (such as Healthcare, or Education). Below are some of the contracts Egan is an official vendor for. For most up to date list, please visit [www.egan.com](http://www.egan.com).



GSA  
CMAS  
MHEC

State of Alabama  
State of Georgia  
State of Pennsylvania  
State of Mississippi  
State of Connecticut



For most up to date list of State Contracts and Buying Groups and contract details visit [www.egan.com](http://www.egan.com).

# TABLE OF CONTENTS

## PRESENTATION BOARDS

<b>Dimension: Overview</b>	7
Dimension Stele 13	8
Dimension Stele	8
Dimension Curve	8
Dimension Stele Integral	8
Dimension Stratus	8
Dimension Hover	8
Dimension Tack	8
Dimension Curve Tack	8
Dimension Stele LINXX	9
Dimension Slider	10-11

<b>Architrave : Overview</b>	12
Architrave Markerboard: EVS, Glass, Tack	13

<b>Boxcore: Overview</b>	14
Boxcore 19: EVS, Glass, Tack	15
Boxcore 29: EVS, Glass, Tack	16
Standing Rigging	17

<b>Classic: Overview</b>	18
Aluminum Frame Markerboard & Tackboard	19
Linked Aluminum Frame Markerboard & Tackboard	20
Aluminum Frame Full Length Marker Tray	21
Hardwood Frame Markerboard & Tackboard	22
Linked Hardwood Frame Markerboard & Tackboard	23

## GLASS MARKERBOARDS

<b>EganAero: Overview</b>	24
EganAero Hover	25
EganAero Boxcore	25
EganAero Architrave	25

<b>GlassWrite: Overview</b>	26
GlassWrite Clear & Frosted	27-28
GlassWrite Shapes	27-28
GlassWrite Colors	27-28
GlassWrite MAG	27-28
GlassWrite Curve	27-28
GlassWrite MAG Curve	27-28
GlassWrite MAG Boxcore	27-28
GlassWrite MAG Architrave	27-28
GlassWrite LINXX	28
GlassWrite Envoy	29

## EGAN WALL SYSTEM

<b>Wall System: Overview</b>	30
VersaPRO® Wallcovering	31
Framing/ Tracks Options	32-34
Egan System Markerboards & Tackboards	35
Lightweight: VersaBoard	36-37
Egan System Shelving	38
Egan System Cabinets	39
VersaJOT	40
VersaMAG	41

## CABINETS

<b>Cabinets: Overview</b>	42
<b>Classic</b>	
Egan Etex Cabinet	43
Egan Wood Cabinet	44
<b>Dimension - VersaCabinet</b>	45
<b>Boxcore Cabinets</b>	
EVS, GlassWrite, EganAero	46

## MOBILES

<b>Mobiles: Overview</b>	47
<b>Architrave Mobile: EVS &amp; Tack</b>	48
<b>Architrave Mobile: Glass</b>	49
<b>Boxcore Mobile: EVS &amp; Tack</b>	50
<b>Boxcore Mobile: Glass</b>	51
<b>V-Series Mobile</b>	
V-Series Mobile - Single Panel & Split Panel	52-53
V-Series Mobile - GlassWrite	54
<b>Lite Mobiles</b>	
Egan Lite Mobile	55
Egan Lite Screen Door Mobile	56
<b>Wall System A-Frame VersaMobile</b>	57

## TABLESCREENS/ DESK DIVIDERS

<b>TableScreens Overview</b>	58
Mount Options	59
<b>Architrave TableScreen: EVS &amp; Tack</b>	60
<b>Architrave TableScreen: Glass</b>	61
<b>Boxcore 29 TableScreen: EVS &amp; Tack</b>	62
<b>Boxcore 29 TableScreen: Glass</b>	63
<b>GlassWrite TableScreens</b>	64
<b>Dimension TableScreens</b>	65
<b>V-Series TableScreens: EVS, Glass, Tack</b>	66
<b>Fabric TableScreens</b>	67

## SOUND IDEAS

<b>Sound Ideas: Overview</b>	68
<b>Egan Disperse</b>	
Mobile	69
Wall Mount	69
<b>Wall Panels</b>	
Acoustical Panel System - Series 3	70-71
Decorative Tack Panels	72

## EGAN LECTERNS

<b>Lecterns: Overview</b>	73
How to Choose an Egan Lectern	74
<b>Technology</b>	
Audio Visual Height Adjustable Lectern	75
TecTern III	76
TecTern S2	77
TecTern TWO	78-79
TecTern	80-81
<b>Contemporary</b>	
202 EganLectern	82
202 Mobile Instruction Center	83
202 ADA	84
OVO	85
<b>Classic</b>	
Wood Veneer EganLectern	86
Wood Veneer ADA	87
Egan Accessories, Supplies & Mounting	88-92

## PROGRAMS & SERVICES

Custom Color Matching, Egan Infinite Color Palette	94
Custom Stain	94
EganINK: Large format graphic printing	95
Egan Fabric Program	96
<b>Cleaning Instructions</b>	97
<b>Purchase Order Requirements</b>	98
<b>Egan Standard Terms &amp; Conditions</b>	99
<b>Freight Program &amp; Egan Standard Warranty</b>	100
<b>Product Code Index</b>	101

# Dimension

# EGAN

## ■ Dimension Stele

Designed specifically for free flow thinking, its clean aesthetic keeps the mind clear and free from distraction. With a 1" or 1/2" profile depth, Dimension Stele is impactful and complementary to any design or environment.

## ■ Dimension LINXX

Create a large, presentation board by linking Dimension boards.

## ■ Dimension Curve

Dimension Curve is built with 4" rounded corners for a softer, smoother design.

## ■ Dimension Plus

All the benefits of Dimension Stele with a bold, prominent profile, in 2" or 3" depths.

## ■ Dimension Integral

Dimension Stele with the added functionality of a marker tray that seamlessly integrates into the board. Dimension Integral features a 3/4" groove to hold whiteboard markers in a fashion that is true to the minimalist design principles of the Dimension line.

## ■ Dimension Stratus

All edges of the board are chamfered back towards the wall at a 15-degree angle resulting in the board's floating appearance.

## ■ Dimension Tack

Dimension Tack is a frameless, squared edge profile that matches the design aesthetic of Dimension Stele. Choose from over 200 fabric options from Guilford of Maine and Maharam or chose Egan EcoTack/Polyethylene Terephthalate (PET), a unique tackable infill that is environmentally friendly, sound-absorptive and fire retardant.

- 42% recycled content and 100% recyclable polyester
- Noise Reduction Coefficient (NRC) of 0.80
- Fire Retardant under ASTM E 84

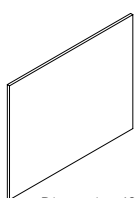

Dimension 13

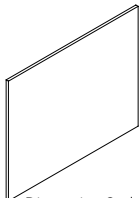

Dimension Stele

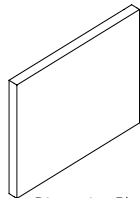

Dimension Plus

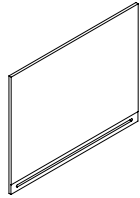

Dimension Integral

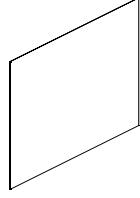

Dimension Stratus

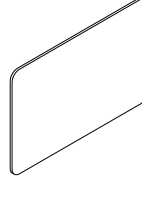

Dimension Curve



Dimension Tack

# DIMENSION

**BUILT  
TO INSPIRE**

# Dimension

Presentation Boards

	Dimension Hover (0.2"d)	Dimension 13 (1/2"d)	Dimension Stele (1"d)	Dimension Integral (1"d)	Dimension Curve (1"d)	Dimension Stratus (1"d)
48"w x 36"h	\$1,100	\$1,250	\$1,270	\$1,450	\$1,460	\$1,550
48"w x 48"h	\$1,210	\$1,310	\$1,330	\$1,510	\$1,530	\$1,640
60"w x 48"h	\$1,410	\$1,430	\$1,450	\$1,710	\$1,670	\$1,750
72"w x 48"h	\$1,700	\$1,510	\$1,530	\$1,790	\$1,760	\$1,830
96"w x 48"h	\$2,330	\$1,700	\$1,740	\$1,980	\$2,010	\$2,030
120"w x 48"h	\$2,820	\$2,260	\$2,310	\$2,560	\$2,660	\$2,630
<b>Projection Compatible</b>						
77"w x 48"h   16:10	-	\$1,630	\$1,670	-	-	\$1,850
82"w x 51"h   16:9	-	\$1,820	\$1,860	-	-	\$2,140

	Dimension Tack EcoTack	Dimension Fabric Tack Standard	Dimension Fabric Tack Grade A	Dimension Curve Fabric Tack Standard	Dimension Curve Fabric Tack Grade A
48"w x 36"h	\$800	\$870	\$1,020	\$990	\$1,140
48"w x 48"h	\$910	\$980	\$1,130	\$1,120	\$1,270
60"w x 48"h	\$1,150	\$1,220	\$1,370	\$1,410	\$1,560
72"w x 48"h	\$1,210	\$1,280	\$1,430	\$1,480	\$1,650
96"w x 48"h	\$1,350	\$1,420	\$1,570	\$1,630	\$1,800
120"w x 48"h	-	-	-	-	-

Custom sizes available - Select next larger size and add \$250 to list / item COM (customer's own material) Upcharge: \$150 List handling fee. Customer required to purchase fabric Boards can be ordered in a linked format. See following page (page 9).

### 1. PRODUCT CODE

Code	Description
DMH	Dimension Hover: 5mm
DM13	Dimension 13: 1/2" Depth
DM	Dimension Stele: 1" Depth
DMI	Integral: Integrated Tray
DMS	Stratus: Knife Edge detail
DMR	Dimension Curve
DT	Dimension Tack 1-1/8" Depth
DTR	Dimension Curve Tack

### 3. TRAY COLOR

Code	Description	Price
WH	White	\$ 0
CC	Custom Color	\$ 250

Applies to Integral (DMI) products only

### 4. SURFACE

Dimension Tack (DT & DTR only)	
F	Fabric
T	EcoTack/PET

For a full list of Standard and Grade A fabric options, visit [egan.com/fabrics-and-textiles/](http://egan.com/fabrics-and-textiles/)

### 2. EDGE COLOR

Code	Description	Price
WH	White	\$ 0
CC	Custom Color	\$ 250

### 5. EGANINK

Specify EganINK on EVS. Please reach to [our team](#) for an [EganINK](#) quote with your custom art file.

### WHAT'S IN THE BOX

Mounting cleats: ACWALMB-Z  
Two (2) assorted color Dry-Erase Markers  
One (1) EganCloth

### HOW TO ORDER

**DM 60 48 WH WH I \_\_\_\_\_**

1. Product Code    Width    Height    2. Edge Color    3. Tray Color (Integral Only)    5. EganINK File # (supplied by Egan)

**DTR 72 48 F 123456-123**

1. Product Code    Width    Height    4. Surface    Maharam or Guildford of Maine Fabric #



# Dimension LINXX

Create a massive professional presentation surface with a monolithic, vanishing edge appearance with outstanding functionality; guaranteed-to-clean, projection-capable, and both standard and Egan NeoMagnet-compatible.

Dimension LINXX uses new Dimension Stele and Stratus (chamfered edge on outer edges only) cleat-mounted boards. To create Presentation Surfaces of varying heights and length combinations for a unique visual appearance.

## Dimension LINXX

Select any combination of DM, DM13, or DMS boards to create your infinite length run. When combining Stratus, only outside boards will be Stratus. When selecting LINXX option, specify outside left (OL), inside board (IB) or outside right (OR). Specifying LINXX" Outside left (OL), inside board (IB) or outside right (OR) for \$80 US list upcharge per board.

## OFFSET Installation

The new Dimension LINXX design gives you the ability to install the individual boards vertically offset for unique appearance!

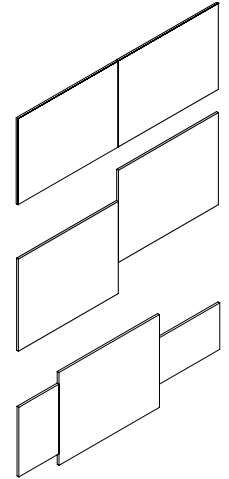

### HOW TO ORDER

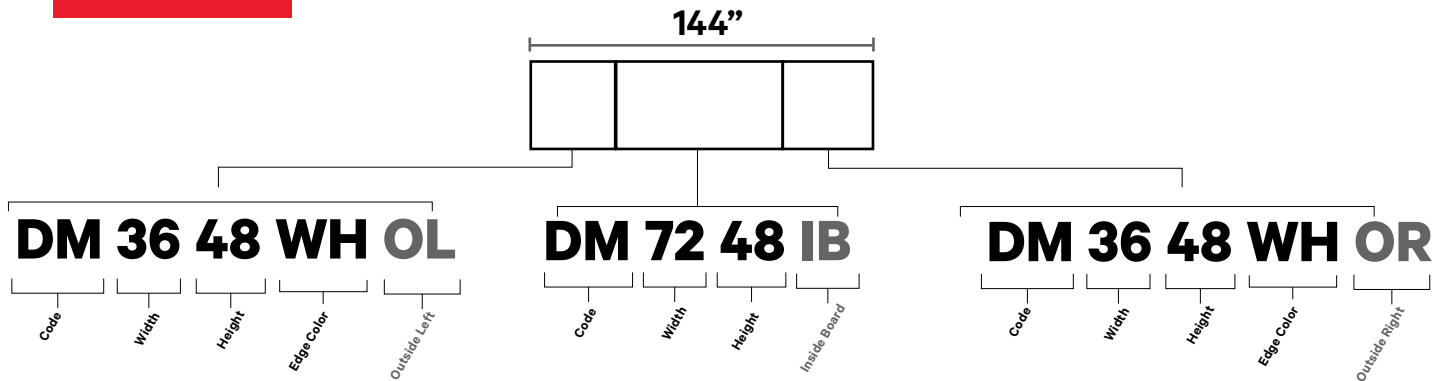

# Dimension Slider

Dimension Slider is built using Dimension 13, DM13, boards (1/2" depth). Dimension 13 boards are cleat mounted to the wall and can be linked together, LINXX, to create presentation surfaces of varying widths. Dimension Slider Boards Rail Kits are designed to allow Dimension 13 Sliding Boards, DMS13, boards to slide smoothly over the face of the wall mounted DM13 boards.

When specifying boards, the front boards should conceal no more than 50% of the back boards. For example, a wall mounted Back Row equalling a width of 192", would have a Front Row of DMS13 boards totaling a width of 96".

Order boards in 3 steps,

Order wall mounted back row boards - order in LINXX configuration or as a single board.

Order rail kits. The rail kit amount should equal the total width of the wall mounted back row.

Order sliding front row boards (width of single or multiple boards should not exceed 50% of the total width of the back row.

## STEP 1

### Wall Mounted Boards - Dimension 13 (1/2"d) (Back Row)

48"w x 48"h	\$1,310
60"w x 48"h	\$1,430
72"w x 48"h	\$1,510
96"w x 48"h	\$1,700
120"w x 48"h	\$2,260

Custom sizes available - Select next larger size and add \$250 to list / item  
Boards can be ordered in a linked format. Add \$80 link kit. See page 11.

## STEP 2

### Rail Kit

48" (4 ft)	RAILKIT-4	\$920
72" (6 ft)	RAILKIT-6	\$1,270
96" (8 ft)	RAILKIT-8	\$1,730
120" (10 ft)	RAILKIT-10	\$2,070
144" (12 ft)	RAILKIT-12	\$2,530

Order rail kit to equal total width of wall mounted back row boards.  
The rail kit amount should equal the total width of the wall mounted back row.  
Rail kits can be field cut and butt jointed to desired length.

## STEP 3

### Sliding Boards (Front Row)

24"w x 52"h	\$1,210
30"w x 52"h	\$1,380
36"w x 52"h	\$1,440
42"w x 52"h	\$1,590
48"w x 52"h	\$1,700

All sliding boards come with hardware needed to mount with the rail kit.

### WHAT'S IN THE BOX

Mounting hardware , (2) color Dry-Erase  
Markers One (1) EganCloth

Continued on next page.

# Dimension Slider

Using the Dimension LINXX configuration, Dimension Slider is built using Dimension 13 boards (1/2" depth). Dimension 13 is cleat mounted to the wall and linked together with an integrated sliding mechanism designed to allow hanging Dimension 13 boards to slide smoothly over the face of the wall mounted boards.

When specifying boards, the front boards should conceal no more than 50% of the back boards. For example, if installing the wall mounted back row that equal a length run of 192", you would specify a length of 96" for the front row (sliding boards).

1. PRODUCT CODE		2. EDGE COLOR		
Code	Description	Code	Description	Price
DMS13	Dimension Slider	WH	White	\$ 0
RAILKIT	Rail Kit	CC	Custom Color	\$ 250
F	Front row (sliding boards)			
B	Back row (wall mount boards)			

## HOW TO ORDER

Order boards in 3 steps,

Order wall mounted back row boards - order in LINXX configuration or as a single board.

Order rail kits. The rail kit amount should equal the total width of the wall mounted back row.

Order sliding front row boards (width of single or multiple boards should not exceed 50% of the total width of the back row).

### EXAMPLE FOR ORDERING NON-LINXX (STANDARD BOARD)

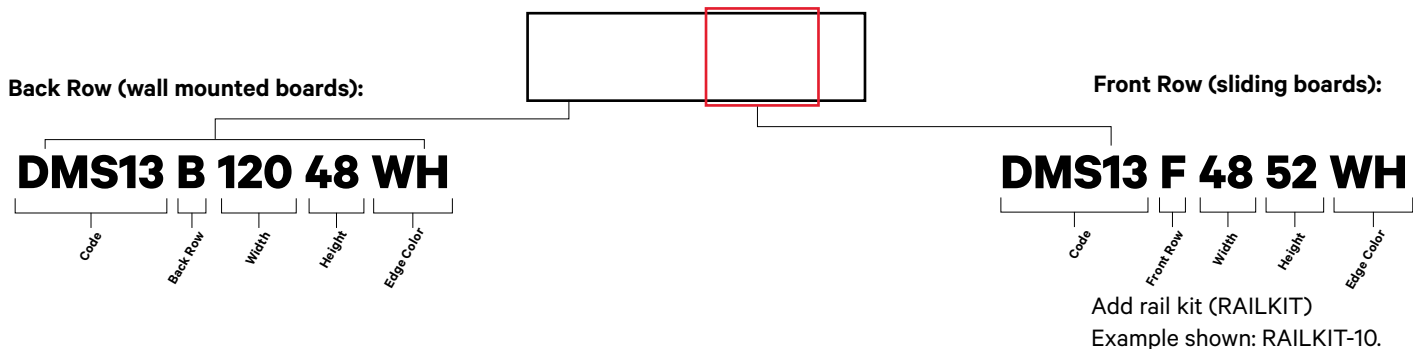

### EXAMPLE FOR ORDERING LINXX

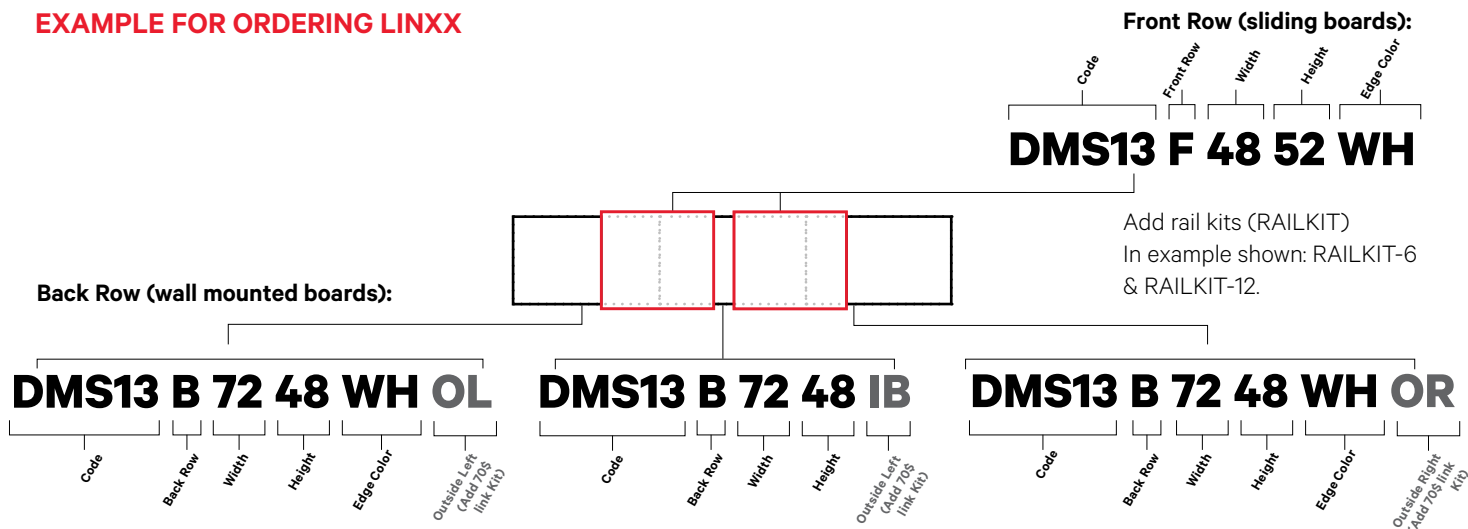

WHAT'S IN THE BOX	
	Mounting hardware , (2) color Dry-Erase Markers One (1) EganCloth

## Architrave

# ARCHITRAVE

**BUILT  
TO INSPIRE**

### ■ Architrave Markerboard | EVS

Enhance your Egan whiteboard by integrating a natural, organic design that will provide a peaceful, calming space for ideas to flow. Available in 4 oak stains - Light Oak, Medium Oak, Dark Oak and Black Oak, visit [Egan.com/oak-stains](http://Egan.com/oak-stains) for more information.

### ■ Architrave | GlassWrite

Specify Egan GlassWrite into any Architrave frame. Available in over 1,050 colors at no extra cost and neo-magnet compatible. Visit [Egan.com/infinite-color-palette](http://Egan.com/infinite-color-palette) to explore all 1,050 colors.

### ■ Architrave | EganAero

EganAero is an ultra thin, hi-tech glass, measuring only 1/50" (2mm) thin. EganAero reduces the drop shadow you get with typical glass. Available in over 1,050 colors at no upcharge and magnet compatible.

### ■ Architrave | Tack

Egan offers a wide range of tackable surfaces. Choose from over 200 fabric options from Guilford of Maine and Maharam or chose Egan EcoTack/Polyethylene Terephthalate (PET), a unique tackable infill that is environmentally friendly, sound-absorptive and fire retardant.

- 42% recycled content and 100% recyclable polyester
- Noise Reduction Coefficient (NRC) of 0.80
- Fire Retardant under ASTM E 84

Stains:

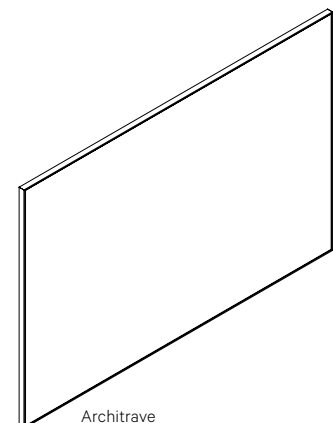

# Architrave

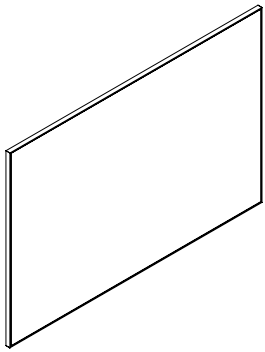

	EVS	GlassWrite MAG	EganAero MAG	Tack EcoTack	Tack Standard Fabric	Tack Grade A Fabric
48" w x 36" h x 1 1/8" d	\$1,030	\$2,180	\$2,530	\$1,030	\$1,160	\$1,280
48" w x 48" h x 1 1/8" d	\$1,170	\$2,640	\$3,080	\$1,170	\$1,300	\$1,420
60" w x 48" h x 1 1/8" d	\$1,320	\$3,040	\$3,500	\$1,320	\$1,450	\$1,570
72" w x 48" h x 1 1/8" d	\$1,410	\$3,440	\$3,980	\$1,410	\$1,600	\$1,730
96" w x 48" h x 1 1/8" d	\$1,880	\$4,120	-	\$1,880	\$2,070	\$2,200
<b>Projection Compatible</b>						
77" w x 48" h   16:10	\$1,810	-	-	-	-	-
82" w x 51" h   16:9	\$2,030	-	-	-	-	-

Custom sizes available - Select next larger size and add \$250 to list / item COM (customer's own material) Upcharge: \$150 List handling fee. Customer required to purchase fabric

Presentation Boards

### 1. PRODUCT CODE

Code	Description
<b>ARC</b>	Architrave

### 2. INFILL

Code	Description
<b>E</b>	EVS
<b>G</b>	Glass: GlassWriteMAG
<b>EA</b>	Glass: EganAero
<b>T</b>	EcoTack /PET
<b>F</b>	Standard Fabric

### 3. FRAME STAINS

Code	Description	Price
<b>LO</b>	Light Oak	\$ 0
<b>MO</b>	Medium Oak	\$ 0
<b>DO</b>	Dark Oak	\$ 0
<b>BO</b>	Black Oak	\$ 0
<b>CS</b>	Custom Stain	\$ 300

### 4. SURFACE

For more information on EganAero Veneer back finishes, visit page 25.

Glass: GlassWrite & EganAero	Price
<b>WH</b> White	\$0
<b>IP</b> Infinite Color Program	\$0
<b>CC</b> Custom Color	\$250

Visit [egan.com](http://egan.com) or [pantone.com](http://pantone.com) for colors. Backpainted glass only.

### 5. EGANINK

Specify EganINK on EVS or Glass. Please reach to [our team](#) for an [EganINK](#) quote with your custom art file.

Tack
<b>F-###</b> Custom & Grade A Fabric

For a full list of Standard and Grade A fabric options, visit [egan.com/fabrics-and-textiles/](http://egan.com/fabrics-and-textiles/)

### HOW TO ORDER

**EVS**

**ARC E 48 48 LO |**

1. Product Code 2. Infill Width Height 3. Frame 5. EganINK File # supplied by Egan

**GLASSWRITE**

**ARC G 48 48 BO WH |**

1. Product Code 2. Infill Width Height 3. Frame 4. Surface 5. EganINK File # supplied by Egan

**FABRIC**

**ARC F 48 48 DO 463490-001**

1. Product Code 2. Infill Width Height 3. Frame Fabric #

### WHAT'S IN THE BOX

Mounting cleats included.  
For dry-erase surfaces, two (2) assorted color Dry-Erase Markers and one (1) EganCloth

### ■ Boxcore 19

Egan Boxcore 19 provides robust edges and clean contemporary esthetics. The Boxcore frame is clear anodized aluminum and sits flush against the wall, with the presentation surface 3/4" (19mm) proud from the wall. The frame features a low profile when viewed from the front. Integrated wallmounts mean the board can be mounted in a landscape or portrait orientation, switching between them easily. Available with EVS, Glass and Tack infills.

### ■ Boxcore 29

Boxcore 29 provides all the benefits of Boxcore 19 but has a bolder design esthetic with a thicker frame (29mm or 1 1/8"), giving the board a deeper profile, sitting more proud off the wall.

### ■ Standing Rigging

Egan Standing Rigging is an architectural-grade installation platform that brings a modern and unique tension wire installation without requiring complicated and custom-engineered architectural rigging. Install Boxcore 29 in any open space, at any height – all you need is a floor and ceiling as anchor points. The finished installation features the board suspended in midair on a simple tensioned wire rope (1x19 SSAC) assembly – with all the parts in the box from Egan. Specify dual infills - EVS, Tackable Fabric or EcoTack - for Boxcore 29 when used with Standing Rigging.

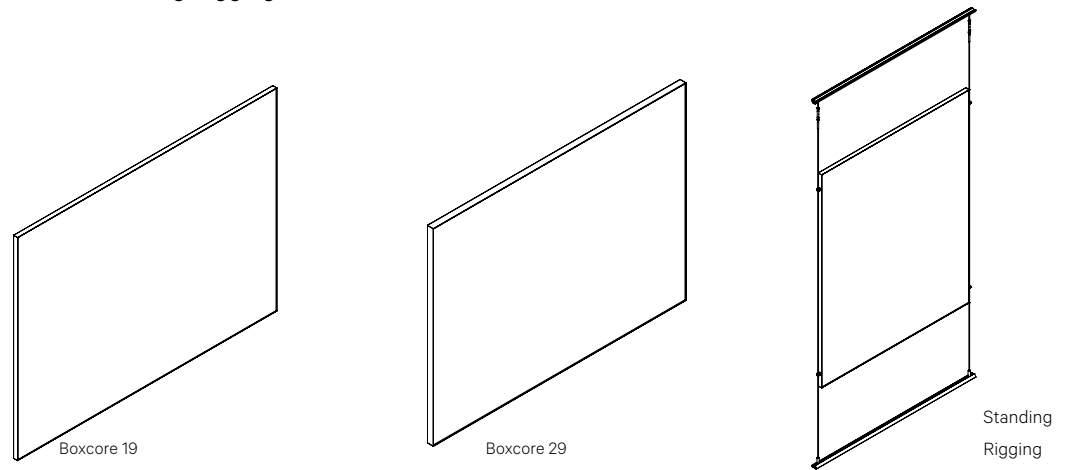

19mm	20mm	25mm	28mm +/- Fabric Thickness	29mm	34mm	37mm +/- Fabric Thickness
Décor Panel EganAero	GlassWrite MAG	Dimension Tack Boxcore (EcoTack)	Dimension Tack Boxcore (Fabric)	Dimension Stele Décor Panel	Dimension Tack Boxcore (EcoTack)	Dimension Tack Boxcore (Fabric)

**BUILT  
TO INSPIRE**

# Boxcore 19

	EVS	GlassWrite MAG	EganAero MAG	Tack EcoTack	Tack Standard Fabric	Tack Grade A Fabric
48" w x 36" h x 3/4" d	\$910	\$2,060	\$2,410	\$910	\$1 030	\$1,150
48" w x 48" h x 3/4" d	\$1,050	\$2,520	\$2,960	\$1,050	\$1 170	\$1,290
60" w x 48" h x 3/4" d	\$1,130	\$2,860	\$ 3,320	\$1,130	\$1 250	\$1,370
72" w x 48" h x 3/4" d	\$1,220	\$3,260	\$3,790	\$1,220	\$1 390	\$1,530
96" w x 48" h x 3/4" d	\$1,710	\$3,950	-	\$1,710	\$1 880	\$2,020
120" w x 48" h x 3/4" d	\$2,120	-	-	-	-	-
<b>Projection Compatible</b>						
77" w x 48" h   16:10	\$1,320	-	-	-	-	-
82" w x 51" h   16:9	\$1,820	-	-	-	-	-

Boards are single sided wallmounted  
 Custom sizes available - Select next larger size and add \$250 to list / item  
 COM (customer's own material) Upcharge: \$150 List handling fee. Customer required to purchase fabric

## 1. PRODUCT CODE

Code	Description
PBB19	EVS
DGMB19	Glass: GlassWrite MAG
EAB19	Glass: EganAero
DTB19	Tack

Boxcore 19 & 29 use the same product code; call out frame selection in description on your Purchase Order (PO)

## 3. FRAME COLOR

Code	Description	Price
CA	Clear Anodized	\$ 0
WH	White	\$ 150
BL	Black	\$ 150
CC	Custom Color	\$ 250

## 2. SURFACE

Glass: GlassWrite & EganAero	
WH	White
IP	Infinite Color Program
Visit <a href="http://egan.com">egan.com</a> or <a href="http://pantone.com">pantone.com</a> for colors. Backpainted glass only.	
Tack	
F	Fabric
T	EcoTack/PET
For a full list of Standard and Grade A fabric options, visit <a href="http://egan.com/fabrics-and-textiles/">egan.com/fabrics-and-textiles/</a>	

## 4. EGANINK

Specify EganINK on EVS or Glass. Please reach to [our team](#) for an [EganINK](#) quote with your custom art file.

## WHAT'S IN THE BOX

Mounting cleats included  
 For dry-erase surfaces, two (2) assorted color Dry-Erase Markers, and one (1) EganCloth

## HOW TO ORDER

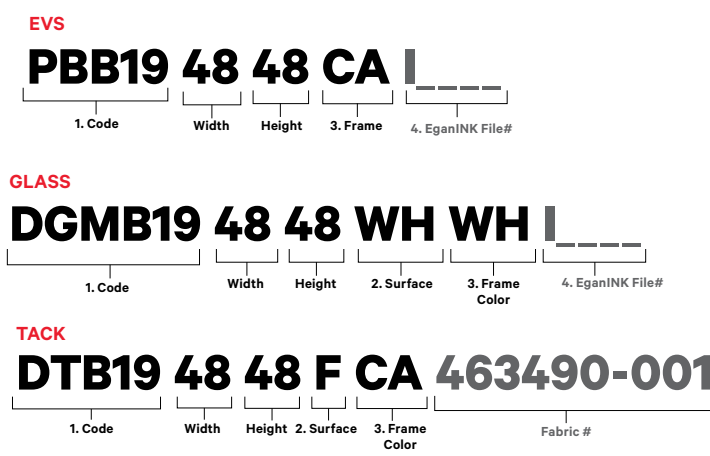

# Boxcore 29

	EVS	GlassWrite MAG	Tack EcoTack	Tack Standard Fabric	Tack Grade A Fabric
48"w x 36"h x 1 1/8"d	\$1,030	\$2,180	\$1,030	\$1,160	\$1,280
48"w x 48"h x 1 1/8"d	\$1,170	\$2,640	\$1,170	\$1,300	\$1,420
60"w x 48"h x 1 1/8"d	\$1,320	\$3,040	\$1,320	\$1,450	\$1,570
72"w x 48"h x 1 1/8"d	\$1,410	\$3,440	\$1,410	\$1,600	\$1,730
96"w x 48"h x 1 1/8"d	\$1,880	\$4,120	\$1,880	\$2,070	\$2,200
120"w x 48"h x 1 1/8"d	\$2,330	-	-	-	-

Projection Compatible					
77"w x 48"h   16:10	\$1,810	-	-	-	-
82"w x 51"h   16:9	\$2,030	-	-	-	-

Boards are single sided wallmounted  
 Custom sizes available - Select next larger size and add \$250 to list / item  
 COM (customer's own material) Upcharge: \$150 List handling fee. Customer required to purchase fabric

## 1. PRODUCT CODE

Code	Description
<b>DMB29</b>	EVS
<b>DGMB29</b>	Glass: GlassWriteMAG
<b>DTB29</b>	Tack

Boxcore 19 & 29 use the same product code; call out frame selection in description on your Purchase Order (PO)

## 2. SURFACE

Tack	
<b>F</b>	Fabric
<b>T</b>	EcoTack/PET

For a full list of Standard and Grade A fabric options, visit [egan.com/fabrics-and-textiles/](http://egan.com/fabrics-and-textiles/)

Glass: GlassWrite	
<b>WH</b>	White
<b>IP</b>	Infinite Color Program
<b>CC</b>	Custom Color

Visit [egan.com](http://egan.com) or [pantone.com](http://pantone.com) for colors. Backpainted glass only.

## 3. FRAME COLOR

Code	Description	Price
<b>CA</b>	Clear Anodized	\$ 0
<b>WH</b>	White	\$ 150
<b>BL</b>	Black	\$ 150
<b>CC</b>	Custom Color	\$ 250

## 4. EGANINK

Specify EganINK on EVS or Glass. Please reach to [our team](#) for an [EganINK](#) quote with your custom art file.

## HOW TO ORDER

**EVS**

**DMB29-48 48 WH I**

1. Product Code    Width    Height    3. Frame    4. EganINK File # supplied by Egan

**GLASS**

**DGMB29-48 48 WH WH I**

1. Product Code    Width    Height    2. Surface    3. Frame Color    4. EganINK File # supplied by Egan

**TACK**

**DTB29-48 48 F CA 463490-001**

1. Product Code    Width    Height    2. Surface    Frame Color    Fabric #

## WHAT'S IN THE BOX

Mounting cleats included.  
 For dry-erase surfaces, two (2) assorted color Dry-Erase Markers, and one (1) EganCloth



# Egan Standing Rigging

Egan Presentation Boards are available wall mount, track mount, wallcovering, freestanding, mobile, and more: now you can specify Egan Boxcore 29 in open environments! Egan Standing Rigging is an all-new architectural-grade installation platform that brings a modern and unique tension wire installation. Install Boxcore 29 in any open space, at any height – all you need is a floor and ceiling as anchor points. The finished installation features the board suspended in midair on a simple tensioned wire rope (1x19 SSAC) assembly – with all the parts in the box from Egan.

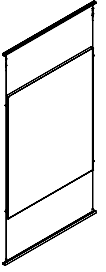

Presentation Boards

### Where To Specify Standing Rigging

Egan Standing Rigging can bring high functionality and modern design esthetic to almost any space. Consider complementing other architectural tension wire assemblies (live walls, rails, etc), creating workspaces in open floorplans, or even to install presentation boards in front of walls which cannot have fixtures (glass walls, demountable walls, partitions, etc).

### How To Specify Boards

Egan Standing Rigging is solely available on Boxcore 29. These boards have two additional features: first, they are optionally manufactured in a double-sided configuration; second, they feature mounting holes on the Boxcore frame for the Standing Rigging hardware.

### How To Specify The Standing Rigging Kit

Order one kit per board to be installed. A Standing Rigging Kit includes hardware suitable for installing one board (of any standard size) with a floor-to-ceiling distance of up to 12'. For greater heights or long continuous runs of boards - please call Customer Service.

Code	Description	Price
<b>ACESR-KIT</b>	Egan Standing Rigging Kit	\$650
<b>ACESR-KIT-ADD</b>	For use with ACESR-KIT when installing 2 or more boards on the same vertical wire	\$440
<b>ACESR-WC</b>	Wire Cutter	Inquire*
<b>ACESR-TG</b>	Tension Gauge	Inquire*

### What's In The Box

Ship with Two (2) assorted color Dry-Erase Markers One (1) EganCloth.

The kit consists of track, wire, board mounts (stops and eye bolts) and termination hardware. What is not included: installation hardware (to mount the track), tools, and the tension gauge. Wire tension of 350lbs is recommended to stabilize the installation, and a wire tension gauge is required to measure this. If cutting the wire, the cut must be clean. If the installer does not have a tension gauge or wire cutter (appropriate for SSAC 1x19, such as Felco cutter), these are widely available and also available from Egan.

### Installation

1. Install the upper and lower track.
2. Slide the turnbuckle into the upper track, with the wires hanging down. The wires have been fixed to the turnbuckle termination at the factory.
3. Screw the eye bolts into the factory-prepared holes on the Dimension Stele Boxcore frame.
4. Feed the wire through the eyebolts and the stop collars, temporarily fixing the stop collars to hold the board in place.
5. Cut off any excess wire and insert the wire into the quick connect fitting.
6. Insert the fitting into the lower track and tighten the turnbuckle to 350 lbs (gauge required).
7. True the board and tighten the stop clamps.

### PRICING SHOWN PER SIDE OF BOXCORE 29

	EVS Code: E	EganAero MAG Code: EA	Tack EcoTack Code: T	Tack Standard Fabric Code: F	Tack Grade A Fabric Code: F
48" w x 36" h x 1 1/8" d	\$700	\$2,240	\$700	\$760	\$840
48" w x 48" h x 1 1/8" d	\$790	\$2,740	\$790	\$860	\$950
60" w x 48" h x 1 1/8" d	\$910	\$3,140	\$910	\$990	\$1,090
72" w x 48" h x 1 1/8" d	\$980	\$3,580	\$980	\$1,050	\$1,150
96" w x 48" h x 1 1/8" d	\$1,310	Inquire	\$1,300	\$1,400	\$1,510
120" w x 48" h x 1 1/8" d	\$1,610	Inquire	-	-	-

### GLASS DOUBLE SIDED BOXCORE 29 PRICING

	GlassWrite MAG Code: GG
48" w x 36" h x 1 1/8" d	\$3,780
48" w x 48" h x 1 1/8" d	\$3,440
60" w x 48" h x 1 1/8" d	\$5,360
72" w x 48" h x 1 1/8" d	\$6,090
96" w x 48" h x 1 1/8" d	\$7,160

\*GlassWrite infills must be specified as two sided for even weight distribution

### Projection Compatible

77" w x 48" h   16:10	\$1,180	-	-	-	-
82" w x 51" h   16:9	\$1,400	-	-	-	-

### HOW TO ORDER

**GLASS**  
**DMB29-48 48 R G G WH WH CA I**

Product Code    Width    Height    Standing Rigging    Side 1: Infill    Side 2: Infill    Side 1: Surface Color/ Fabric    Side 2: Surface Color/ Fabric    Frame    4. EganINK File # supplied by Egan

## Classic Boards

### ■ Aluminum Frame | Markerboard & Tackboard

Aluminum Frame Markerboards feature EVS™ surface, Porcelain, or tackable fabric framed in clear anodized aluminum frame with precision square mitered corners. Guaranteed-to-clean and never warp, Egan Aluminum Frame Markerboards are magnet-compatible.

### ■ Linked Aluminum Frame

Link any combination of Markerboards and Tackboards to create a superior quality communication wall.

### ■ Aluminum Frame w/ Full Length Integrated Tray

Aluminum Frame Markerboard integrated with the exquisite custom-fit Full Length Aluminum Marker Tray. The Tray's clean edges and contemporary design blends perfectly with the Clear Anodized frame.

### ■ Hardwood Frame | Markerboard & Tackboard

A solid hardwood frame with a 1/2" bullnose edge. Satin lacquer in an open-grain finish gives this robust markerboard excellent appeal. Available in EVS, Porcelain or Tack.

### ■ Linked Hardwood Frame

Featuring high-performance EVS or porcelain with hardwood frames - 1" wood frame with a 1/2" bullnose detail. Link any combination of Linked Markerboards and Tackboards to create a superior quality communication wall.

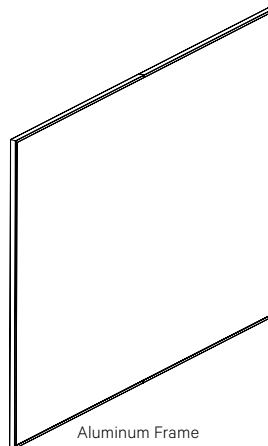

Aluminum Frame

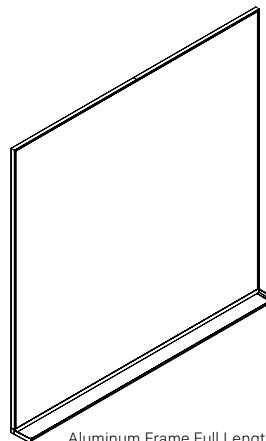

Aluminum Frame Full Length Tray

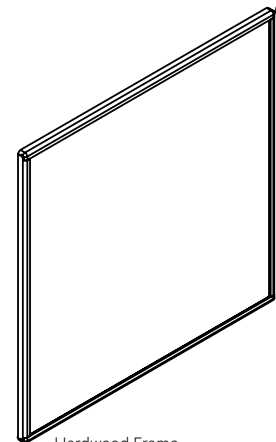

Hardwood Frame

# Aluminum Frame Markerboard & Tackboard

Presentation Boards

	EVS	Porcelain	Tack Standard Fabric	Tack Grade A Fabric	Tack Cork
24"w x 36"h	\$400	\$460	\$460	\$590	\$590
48"w x 36"h	\$610	\$670	\$680	\$810	\$810
48"w x 48"h	\$730	\$800	\$800	\$930	\$930
60"w x 48"h	\$860	\$940	\$930	\$1,060	\$1,060
72"w x 48"h	\$980	\$1,090	\$1,030	\$1,180	\$1,180
96"w x 48"h	\$1,170	\$1,290	\$1,230	\$1,380	\$1,380
120"w x 48"h	\$1,530	-	-	-	-
<b>Projection Compatible</b>					
77"w x 48"h   16:10	\$1,150	-	-	-	-
82"w x 51"h   16:9	\$1,370	-	-	-	-

Custom Color Frame: Additional \$250

Custom sizes available - Select next larger size and add \$250 to list / item

COM (customer's own material) Upcharge: \$150 List handling fee. Customer required to purchase fabric

## 1. PRODUCT CODE

Code	Description
MES	EVS   Square Frame
MDWP	White Porcelain   Square Frame
MDTS	Tack Fabric   Square Frame
MDCS	Tack Cork   Square Frame

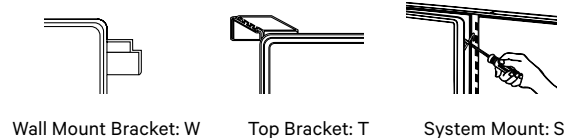

## 2. MOUNT

Code	Description	Price
W	Wall Mount	\$ 0
T	Top Bracket (1 3/4" to 2 3/4")	\$ 0
T-EOEX	Top Bracket Extended (2 3/4"-4")	\$ 12
S	System Mount	\$ 0

Top Mount brackets are universal and can be easily adjusted to accommodate any workstation panel measuring from 1 3/4" to 2 3/4" thick. For panels 2 3/4"-4" deep please specify EOEX at \$12. Adjustable by 1/8" increments. Due to weight restraints, 72" x 48", 82" x 51", 96" x 48", and 120" x 48" boards are not available with System Mount (contact customer service for select Top Mount sizes). Brackets are aluminum with a clear anodized finish. Custom colors are not available on the brackets. Plastic protective sleeves are included to assure no damage is caused to the system.

## 3. EGANINK

Specify EganINK on EVS. Please reach to [our team](#) for an [EganINK](#) quote with your custom art file.

## HOW TO ORDER

**DRY ERASE**

**MES 60 48 W I**

1. Product Code      Width      Height      2. Mount      3. EganINK File# (supplied by Egan)

**TACK**

**MDTS 72 48 W 463490-001**

1. Product Code      Width      Height      2. Mount      Fabric #

## WHAT'S IN THE BOX

Mounting brackets as specified  
 16" EM Marker Tray included with writing surface  
 For dry-erase surfaces, two (2) assorted color, Dry-Erase Markers,  
 one (1) EganCloth, and one (1) Marker Tray

## NOTES

For a full list of Standard and Grade A fabric options, visit [egan.com/fabrics-and-textiles/](http://egan.com/fabrics-and-textiles/)

# Linked Aluminum Frame

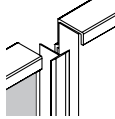

Board Link Detail

	EVS	Porcelain	Tack Standard Fabric	Tack Grade A Fabric	Tack Cork
24"w x 36"h	\$510	\$570	\$570	\$700	\$700
48"w x 36"h	\$680	\$720	\$680	\$810	\$810
48"w x 48"h	\$800	\$840	\$840	\$970	\$970
60"w x 48"h	\$910	\$980	\$970	\$1,100	\$1,100
72"w x 48"h	\$1,060	\$1,120	\$1,080	\$1,230	\$1,230
96"w x 48"h	\$1,250	\$1,340	\$1,290	\$1,440	\$1,440
120"w x 48"h	\$1,590	-	-	-	-

Custom Color Frame: Additional \$250

Custom sizes available - Select next larger size and add \$250 to list / item

COM (customer's own material) Upcharge: \$150 List handling fee. Customer required to purchase fabric

Presentation Boards

## 1. PRODUCT CODE

Code	Description
I	Linked Aluminum Frame

## 2. SURFACE

Dry Erase	
E	EVS
WP	White Porcelain
T	Tack Fabric
C	Tack Cork

For a full list of Standard and Grade A fabric options, visit [egan.com/fabrics-and-textiles/](https://egan.com/fabrics-and-textiles/)

## EGANINK

Specify EganINK on EVS. Please reach to [our team](#) for an [EganINK](#) quote with your custom art file.

## 3. CORNERS

Square	Description
S	Outside Left and Outside Right boards only

## WHAT'S IN THE BOX

Mounting brackets as specified  
For dry-erase surfaces, two (2) assorted color Dry-Erase Markers, and one (1) EganCloth

## 4. POSITION

Code	Description
OL	Outside Left
IB	Inside Board
OR	Outside Right

## 5. MOUNT

Code	Description
W	Wall Mount



## HOW TO ORDER

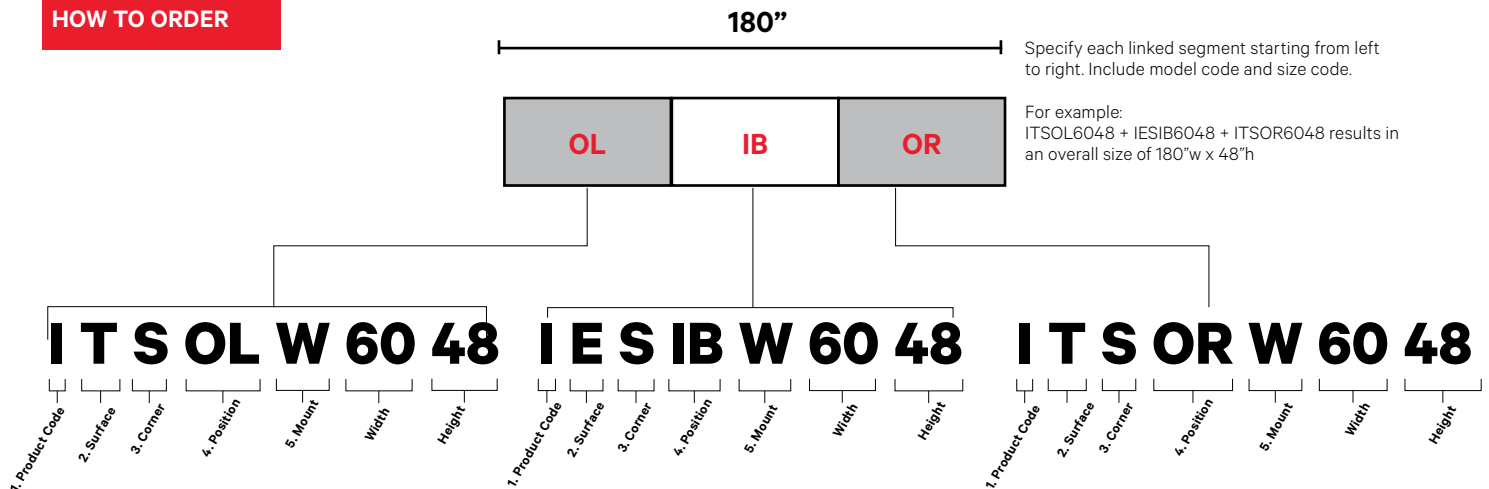

# Markerboard with Integrated Full Length Marker Tray

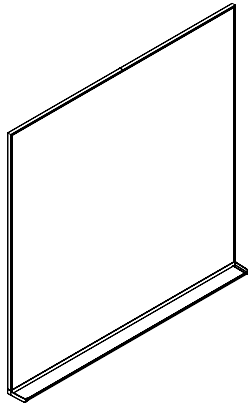

	EVS	Porcelain
24" w x 36" h	\$450	\$530
48" w x 36" h	\$690	\$750
48" w x 48" h	\$820	\$900
60" w x 48" h	\$970	\$1,060
72" w x 48" h	\$1,130	\$1,210
96" w x 48" h	\$1,340	\$1,450
120" w x 48" h	\$1,720	

Custom Color Frame: Additional \$250  
 Custom sizes available - Select next larger size and add \$250 to list per item

Presentation Boards

## 1. PRODUCT CODE

Code	Description
<b>MFTES</b>	EVS   Square Frame
<b>MFTMS</b>	Porcelain   Square Frame

## 2. MOUNT

Code	Description	Price
<b>W</b>	Wall Mount	\$ 0
<b>T</b>	Top Bracket (1 3/4" to 2 3/4")	\$ 0
<b>T-EOEX</b>	Top Bracket Extended (2 3/4"-4")	\$ 12
<b>S</b>	System Mount	\$ 0



Wall Mount Bracket: W

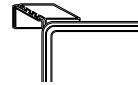

Top Bracket: T

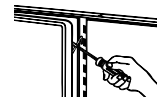

System Mount: S

Top Mount brackets are universal and can be easily adjusted to accommodate any workstation panel measuring from 1 3/4" to 2 3/4" thick. For panels 2 3/4"-4" deep please specify EOEX at \$12. Adjustable by 1/8" increments. Due to weight restraints, 72" x 48", 82" x 51", 96" x 48", and 120" x 48" boards are not available with System Mount (contact customer service for select Top Mount sizes). Brackets are aluminum with a clear anodized finish. Custom colors are not available on the brackets. Plastic protective sleeves are included to assure no damage is caused to the system.

## 3. EGAINK

Specify EganINK on EVS. Please reach to [our team](#) for an [EganINK](#) quote with your custom art file.

## HOW TO ORDER

**MFTES 60 48 W I \_\_\_\_\_**

1. Product Code      Width      Height      2. Mount Option      3. EganINK File # (supplied by Egan)

## WHAT'S IN THE BOX

Mounting brackets as specified  
 For dry-erase surfaces, two (2) assorted color Dry-Erase Markers, and one (1) EganCloth

# Hardwood Frame Markerboard & Tackboard

Presentation Boards

	EVS	Porcelain	Tack Standard Fabric	Tack Grade A Fabric	Tack Cork
48" w x 36" h	\$1,050	\$1,130	\$1,130	\$1,270	\$1,270
48" w x 48" h	\$1,140	\$1,280	\$1,260	\$1,400	\$1,400
60" w x 48" h	\$1,280	\$1,450	\$1,380	\$1,520	\$1,520
72" w x 48" h	\$1,480	\$1,600	\$1,530	\$1,670	\$1,670
96" w x 48" h	\$1,700	\$1,790	\$1,690	\$1,830	\$1,830

Custom Stain Frame: Additional \$300  
 Custom sizes available - Select next larger size and add \$250 to list / item  
 COM (customer's own material) Upcharge: \$150 List handling fee. Customer required to purchase fabric

## 1. PRODUCT CODE

Code	Description
MEW	EVS
MDMW	Porcelain
MDTW	Tack Fabric
MDCW	Tack Cork

For a full list of Standard and Grade A fabric options, visit [egan.com/fabrics-and-textiles/](https://egan.com/fabrics-and-textiles/)

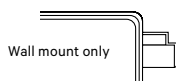

## 2. STAINS

Code	Description
LO	Light Oak
MO	Medium Oak
DO	Dark Oak
BO	Black Oak
MA	Mahogany
CH	Cherry
MP	Natural Maple
WA	Walnut
CS	Custom Stain available Add \$300 to list, per board

## 3. EGANINK

Specify EganINK on EVS. Please reach to [our team](#) for an [EganINK](#) quote with your custom art file.

## HOW TO ORDER

EVS

**MEW 48 48 CH I \_\_\_\_\_**

1. Product Code      Width      Height      2. Stains      3. EganINK File # (supplied by Egan)

TACK

**MDTW 24 36 MP 463490-001**

1. Product Code      Width      Height      2. Stains      Fabric #

## WHAT'S IN THE BOX

Mounting brackets as specified  
 For Dry-erase surfaces, two (2) assorted color Dry-Erase Markers, one (1) EganCloth

# Linked Hardwood Frame



Edge detail

	EVS	Porcelain	Tack Standard Fabric	Tack Grade A Fabric	Tack Cork
48" w x 36" h	\$1,100	\$1,180	\$1,170	\$1,300	\$1,300
48" w x 48" h	\$1,180	\$1,210	\$1,280	\$1,410	\$1,410
60" w x 48" h	\$1,330	\$1,490	\$1,410	\$1,540	\$1,540
72" w x 48" h	\$1,530	\$1,650	\$1,550	\$1,700	\$1,700
96" w x 48" h	\$1,750	\$1,820	\$1,750	\$1,900	\$1,900

Custom sizes available - Select next larger size and add \$300 to list / item COM (customer's own material) Upcharge: \$150 List handling fee. Customer required to purchase fabric

## 1. PRODUCT CODE

Code	Description
IW	Linked Hardwood Frame

## 4. STAINS

Code	Description
LO	Light Oak
MO	Medium Oak
DO	Dark Oak
BO	Black Oak
MA	Mahogany
CH	Cherry
MP	Natural Maple
WA	Walnut
CS	Custom Stain available Add \$300 to list, per board

## 2. SURFACE

Dry Erase	
E	EVS
B	Porcelain
C	Tack Cork
T	Tack Fabric

For a full list of Standard and Grade A fabric options, visit [egan.com/fabrics-and-textiles/](https://egan.com/fabrics-and-textiles/)

## 3. POSITION

Code	Description
OL	Outside Left
IB	Inside Board
OR	Outside Right

## EGANINK

Specify EganINK on EVS. Please reach to [our team](#) for an [EganINK](#) quote with your custom art file.

## HOW TO ORDER

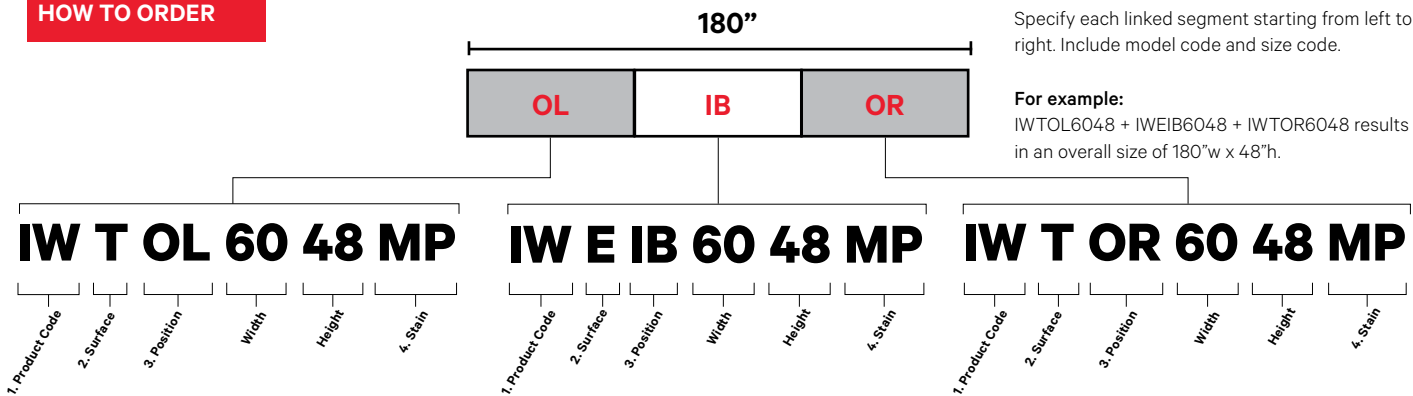

Specify each linked segment starting from left to right. Include model code and size code.

**For example:**  
IWTOL6048 + IWEIB6048 + IWTOR6048 results in an overall size of 180" w x 48" h.

## WHAT'S IN THE BOX

Wall mount bracket and link connectors  
For dry-erase surfaces, two (2) assorted color Dry-Erase Markers, one (1) EganCloth

## EganAero Glass Markerboards

### ■ EganAero Hover

EganAero Hover is an ultra-thin high-tech glass. It is installed with a cleat mount, giving the effect of it floating off the wall. Neo-Magnet compatible.

### ■ EganAero MAG Boxcore

The Egan Boxcore frame provides a 19mm 3/4" (19mm) thin bezeled aluminum frame that sits flush against the wall. Neo-Magnet compatible.

### ■ EganAero Architrave

Enhance your frame with Architrave, an Oak species available in 4 different stain options. Neo-Magnet compatible.

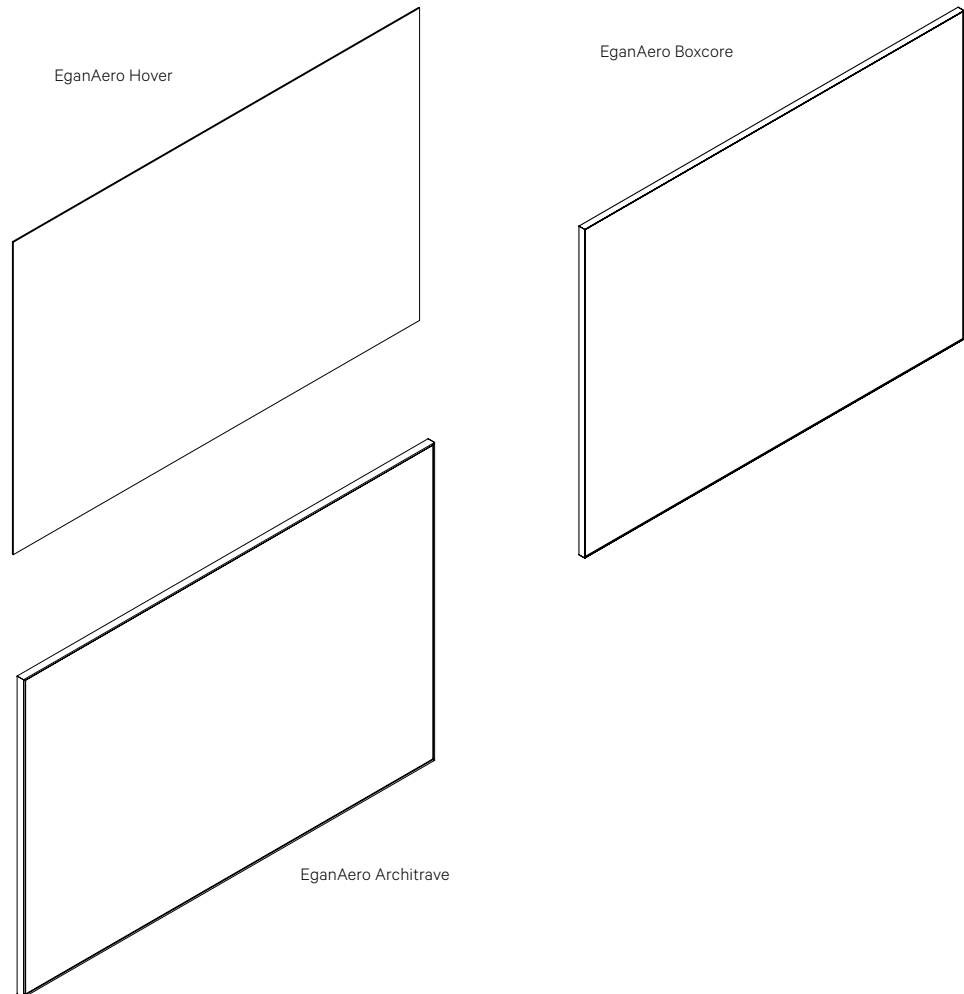



# EganAero

	Aero Hover	Aero Boxcore 19	Aero Architrave
48" w x 36" h	\$2,110	\$2,410	\$2,530
48" w x 48" h	\$2,640	\$2,960	\$3,080
60" w x 48" h	\$2,750	\$ 3,320	\$3,500
72" w x 48" h	\$3,210	\$3,790	\$3,980
96" w x 48" h		Inquire	

## 1. PRODUCT CODE

Code	Description
<b>EAH</b>	EganAero Hover
<b>EAB</b>	EganAero Boxcore
<b>ARCEA</b>	Egan Aero Architrave

## 2. SURFACE

EganAero is available in solid back paint or veneer backers for real wood texture.

BACK PAINT FINISH OPTION		
Code	Description	Price
<b>WH</b>	White	\$0
<b>IP</b>	Infinite Color Program	\$0
<b>CC</b>	Custom Color	\$250
Visit <a href="http://egan.com">egan.com</a> or <a href="http://pantone.com">pantone.com</a> for colors. Backpainted glass only.		

WOOD VENEER BACKER FINISH		
Code	Description	Price
<b>BA</b>	Brushed Aluminum	\$0
<b>GO</b>	Grey Oak	\$0
<b>LO</b>	Light Oak	\$0
<b>MP</b>	Maple	\$0

## 3. FRAME

Frame options include:  
 1. Frameless (Hover)  
 2. Hardwood Frame (Architrave)  
 3. Ultra Thin Bezel Aluminum (Boxcore 19)

ARCHITRAVE FRAME STAINS		
Code	Description	Price
<b>LO</b>	Light Oak	\$ 0
<b>MO</b>	Medium Oak	\$ 0
<b>DO</b>	Dark Oak	\$ 0
<b>BO</b>	Black Oak	\$ 0
<b>CS</b>	Custom Stain	\$ 300

BOXCORE FRAME COLORS		
Code	Description	Price
<b>CA</b>	Clear Anodized	\$ 0
<b>WH</b>	White	\$ 150
<b>BL</b>	Black	\$ 150
<b>CC</b>	Custom Color	\$ 250

## 4. EGANINK

Specify EganINK on Glass. Please reach to [our team](#) for an [EganINK](#) quote with your custom art file.

## HOW TO ORDER

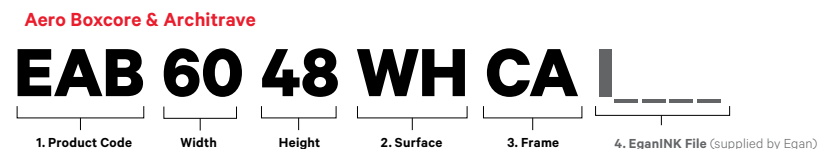
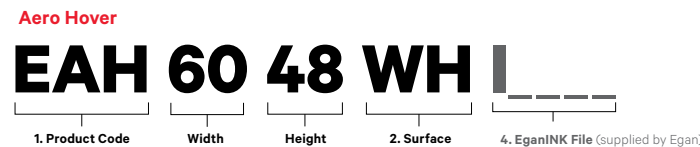

## WHAT'S IN THE BOX

- Mounting brackets as specified
- Two (2) assorted color Dry-Erase Markers
- Two (2) NeoMagnets
- One (1) EganCloth

## GlassWrite Markerboards

### ■ GlassWrite | Clear & Frosted

All Egan GlassWrite product are made with high quality, low iron tempered safety glass with a 1/5" (5mm) thickness - stanchion mount only.

### ■ GlassWrite | Colors

Bring color to your workplace! Specify from over 1,000 standard colors at no upcharge - stanchion mount only.

### ■ GlassWrite Shapes

We work with Designers and Clients to develop custom glass solutions design around your space. Contact your local Rep or our Customer Service team for more information.

### ■ GlassWriteMAG

All the benefits of GlassWrite Color with added functionality of magnet compatibility - cleat mount only.

### ■ GlassWrite Curve

GlassWrite Curve is built with 4" rounded corners for a softer, smoother design.

### ■ GlassWriteMAG Boxcore

The Egan Boxcore frame provides a 3/4" (19mm) thin bezeled aluminum frame that sits flush against the wall.

### ■ GlassWrite Envoy

GlassWrite Envoy brings a high design element to your artwork, graphics, care board, wayfinding, or any other art you envision. Change your artwork easily, and without the use of tools - stanchion or cleat mount available.

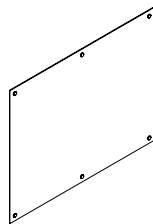

GlassWrite Frosted & Clear  
GlassWrite Colors

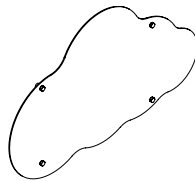

GlassWrite Shapes

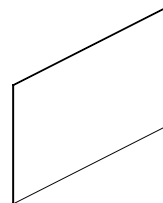

GlassWrite MAG

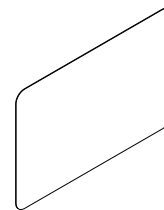

GlassWrite Curve

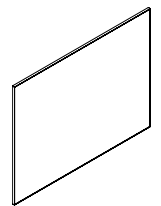

GlassWrite MAG  
Boxcore

GlassWrite is built from a guaranteed-to-clean, crystal clear, low iron tempered safety glass. Offered as frameless 1/4" (5 mm) thick dry erase glass or framed with Boxcore or Architrave. GlassWrite boards are finished with polished edges and are available as clear, frosted, in color, as neo-magnet compatible.

	Clear	Frosted	Colors Cleat	Colors Stanchion	Colors Curve	MAG	MAG Curve	MAG Boxcore 19	MAG Boxcore 29	MAG Architrave
48" w x 36" h	\$1,180	\$1,180	\$1,240	\$1,370	\$1,310	\$1,550	\$1,670	\$2,060	\$2,180	\$2,180
48" w x 48" h	\$1,330	\$1,330	\$1,510	\$1,760	\$1,690	\$1,840	\$2,010	\$2,520	\$2,640	\$2,640
60" w x 48" h	\$1,370	\$1,370	\$1,570	\$1,880	\$1,810	\$2,120	\$2,330	\$2,860	\$3,040	\$3,040
72" w x 48" h	\$1,700	\$1,700	\$1,980	\$2,240	\$2,270	\$2,520	\$2,780	\$3,260	\$3,440	\$3,440
96" w x 48" h	\$2,050	\$2,050	\$2,350	\$2,700	\$2,750	\$3,100	\$3,450	\$3,950	\$4,120	\$4,120
120" w x 48" h	\$2,430	\$2,430	\$3,060	\$3,420	\$3,550	\$3,850	\$4,290	-	-	-

Custom sizes available - Call Sales for quote.  
GlassWrite Shapes - Call for Spot Quote

### MATTE GLASSWRITE

GlassWrite products are also offered in a Matte finish. Matte GlassWrite has a low gloss finish to reduce glare from ambient light.

	Clear	Color Cleat	MAG	MAG Boxcore 19	MAG Architrave
48" w x 36" h	\$1,370	\$1,420	\$1,750	\$2,260	\$2,370
48" w x 48" h	\$1,590	\$1,780	\$2,110	\$2,790	\$2,900
60" w x 48" h	\$1,710	\$1,900	\$2,450	\$3,190	\$3,370
72" w x 48" h	\$2,100	\$2,390	\$2,930	\$3,660	\$3,850
96" w x 48" h	\$2,580	\$2,890	\$3,630	\$4,480	\$4,650
120" w x 48" h	\$3,100	\$3,730	\$4,510	-	-

Custom sizes available - Call Sales for quote.

#### 1. PRODUCT CODE

Code	Description	Mount
DGC	GlassWrite Clear	P
DGF	GlassWrite Frosted	P
DG	GlassWrite Color	P & C
DGM	GlassWrite MAG	C
DGR	GlassWrite Curve	C
DGMR	GlassWrite MAG Curve	C
DGMB	GlassWrite MAG Boxcore	C
ARCG	GlassWrite Architrave	C

#### 2. MOUNT

Code	Description
P	Stanchion
C	Cleat

#### 4. FRAME

BOXCORE FRAME COLORS

Code	Description	Price
CA	Clear Anodized	\$ 0
WH	White	\$150
BL	Black	\$150
CC	Custom Color	\$ 250

#### 3. SURFACE

\* Not applicable for DGC, & DGF only  
\* Visit [egan.com](http://egan.com) or [pantone.com](http://pantone.com) for colors.

Code	Description	Price
WH	White	\$ 0
IP	Infinite Color Program	\$ 0
CC	Custom Color	\$ 250

ARCHITRAVE FRAME STAINS

Code	Description	Price
LO	Light Oak	\$ 0
MO	Medium Oak	\$ 0
DO	Dark Oak	\$ 0
BO	Black Oak	\$ 0
CC	Custom Stain	\$ 300

#### 5. EGANINK

Specify EganINK on Glass. Please reach to [our team](#) for an [EganINK](#) quote with your custom art file.

How to Order and GlassWrite LINXX on next page (page 26)

# GlassWrite™ & GlassWrite LINXX

## HOW TO ORDER

DGC

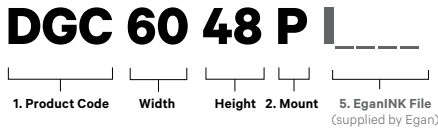

DG | DGM



DGMB

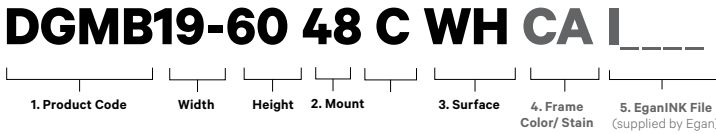

ARCG

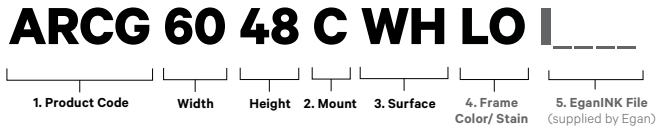

## WHAT'S IN THE BOX

Mount specified included, Two (2) assorted color Dry-Erase Markers, One (1) EganCloth, Magnetic GlassWrite boards ONLY Two (2) Neo-Magnets.

## GlassWrite LINXX

Create a massive professional presentation surface with outstanding functionality, and guaranteed-to-clean. Specify with Egan Ink to customize your GlassWrite LINXX boards.

Select a combination of GlassWrite, GlassWrite Colors (DG) or GlassWrite MAG (DGM), boards to create your infinite length run. GlassWrite LINXX is installed cleat mount with a hover appearance. The presentation surface is linked using a vertical ABS black plastic extrusion.

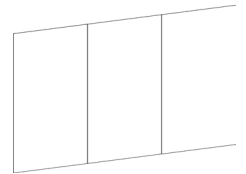

LINXX. Code: ACDGLINK-KIT###. Two each ACDGLINK-KIT 48" required. List charge of \$70 per link.

Standard Sizes: 48, 60, 72, 96", specify 2 each 60" lengths for 120" high boards. Link kit ACDGLINK-KIT### adds 1/8" per seam to overall width.

## HOW TO ORDER

144-1/4"

### Specifying LINXX:

2 each ACDGLINK-KIT48 required.  
List charge of \$70 per link.

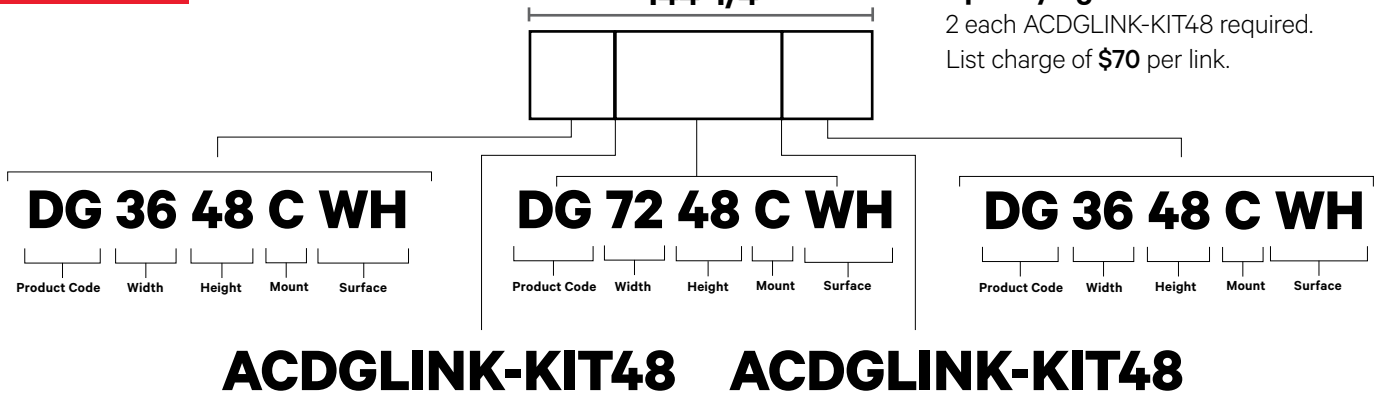

# GlassWrite Envoy

A display and presentation board providing patient, guest or signage solution. GlassWrite Envoy is designed for continued and dynamic use with its dry-erase, guaranteed-to-clean, crystal clear glass covering. Leverage artwork, charts, images and information in lightweight boards, which can be easily switched without the use of tools. To change your artwork, simply slide your boards under the GlassWrite surface.

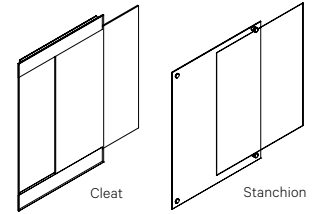

	Stanchion Mount	Cleat Mount	Optional Décor Insert*
24" w x 36" h (Decor Panel 23" w x 35" h x .023" d)	\$630	\$720	\$230*
27" w x 40" h (Decor Panel 26" w x 39" h x .023" d)	\$730	\$830	\$290*
36" w x 48" h (Decor Panel 35" w x 47" h x .023" d)	\$1,510	\$1,720	\$350*
40" w x 60" h (Decor Panel 39" w x 59" h x .023" d)	\$1,740	\$1,990	\$500*

Custom sizes available - Call Sales for quote.

\*Decor panel insert sold separately, add price in chart above to overall list price. Printed one side.

\*\*Optional EganINk on top and bottom (3" border) for cleat mount Envoy

## 1. PRODUCT CODE

Code	Description
DGE	GlassWrite Envoy

## 2. MOUNT

Code	Description
P	Stanchion
C	Cleat

Top and bottom of cleat mount is NeoMagnet compatible.

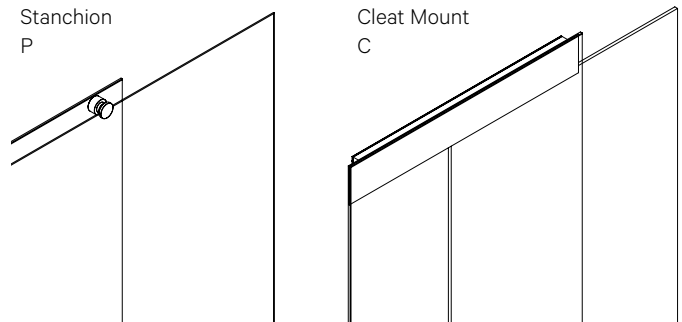

## 3. EGANINK

Specify EganINk on Glass. Please reach to [our team](#) for an [EganINk](#) quote with your custom art file.

## HOW TO ORDER

**DGE 60 48 P | \_\_\_\_\_**

1. Product Code      Width      Height      2. Mount      3. EganINk File (supplied by Egan)

## WHAT'S IN THE BOX

- Mount specified included
- Two (2) assorted color Dry-Erase Markers
- One (1) EganCloth

Glass Markerboards

## Egan Wall System

### ■ VersaPRO® Wallcovering

---

Egan VersaPRO® high performance EVS™ dry-erase surface is designed for quick and easy installation by qualified installers, and is manufactured from similar materials to VersaJOT. Optional EganSystem Track framing is recommended. Volume pricing is available. All edges are straight cut. No custom shape options are available. VersaPRO can be imprinted with EganINK™ on 48" or 54" heights and 1 foot – 400 foot lengths.

Note: VersaPRO installation surfaces require specific surface conditions be met.

Note: continuous patterns over 9' may have design restrictions. Please contact Customer Service for further details.

### ■ Track & Trim

---

Egan offers a wide range of track and trim options to complete and surround installed VersaPro-G Wallcovering. Various Track options are available, providing the opportunity to create an Egan Wall that is tailored to your needs.

### ■ Markerboard | Tackboards | Shelving | Cabinets

---

Provide additional functionality to your Egan Wall System with Markerboards, Tackboards, Shelving and Cabinets, all designed to integrate on the Egan track system for a fluid, dynamic and multi-purpose work area.

### ■ VersaJOT & VersaMAG

---

VersaJOT and VersaMAG are perfect applications for areas that require small, non permanent labeling and signage. VersaJOT is a peel and stick EVS surface that is available in smaller dimensions for personal usage. VersaMAG is EVS applied to a magnet. It installs magnetically on any metal surface, and is offered in popular sizes or as custom shaped. VersaMAG is ideal for smaller locations where a metal surface can be upgraded for dry-erase use. EganINK™ adds branding and increases functionality.

# VersaPRO® Wallcovering

VersaPRO-G is the choice where high expectation fit and finish is required in a floor to ceiling/wall to wall installation (note: visible seams to be expected). And must be installed exactly in position, VersaPRO-G utilizes a customer supplied wet adhesive that provides workable drying time and fitting around details like electrical fixtures.

For wallcovering fit and finish and full wall to ceiling, VersaPRO-G is offered in rolls or sheets. All edges are straight cut (factory slitting is available, custom shape options are not available).

VersaPRO can be imprinted with EganINK on heights: 48" or 54" lengths: 10 feet - 400 feet.

## VersaPRO (VP)



Code	Description	Price	Price/ft - in addition to 10'
VP12054G	10'w x 54"h VersaPRO roll	\$1,000	\$ 100
VP12048G	10'w x 48"h VersaPRO roll	\$1,000	\$ 100

- Egan guarantees +/- 1/16" height accuracy and -0, +2" width accuracy
- See VersaPRO Crate below for higher volumes
- VersaPRO may be slit horizontally for custom applications. Contact Inside Sales for pricing. For multiple heights contact Customer Service
- Ships with two (2) assorted color Dry-Erase Markers and one (1) EganCloth

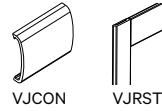
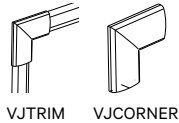

Code	Description	Price
VJTRIM96EM10	3/4" x 96" lengths of Versa Trim in EganMetallic (EM). Box of 10.	\$ 430
VJCORNEREM20	Versa Trim Corner pieces in EganMetallic (EM). Box of 20.	\$ 200
VJCONTEM20	Versa Trim Connectors pieces in EganMetallic (EM). Box of 20.	\$ 200
VJRST96EM	Versa Resurfacing Trim 7/16" x 96" lengths. Box of 10.	\$ 320
EWHTEM	60" lengths of EganSystem Track (top/bottom pair). EganMetallic (EM). Suitable for butt-joining to any length.	\$ 190
EHWVT54	60" lengths of vertical trim (right/left pair). 11/16"w. EganMetallic (EM). Can be field cut for 48"h or 54"h installations.	\$ 150

- EganSystem product line can be used on trimming solutions applied on VersaPRO installed in your environment. Egan System includes double-sided markerboards and tackboards as well as an array of presentation shelves and marker tray options to enhance your presentation environment. Installing EganSystem products on top of VersaPRO multiplies presentation real estate. Egan also encourages properly installed third party framing to match the existing décor
- 96" lengths EMST also available

## HOW TO ORDER

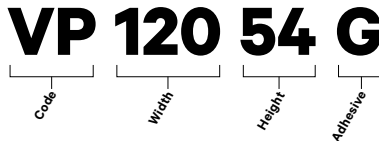

**Egan Visual is not responsible for installation.**

**Customers Own Glue (COG)** installation is able to meet high expectation fit and finish when installed by a professional wallcovering specialist or qualified installer using customer's own wallcovering adhesive. The surface will be available for use after the installer supplied adhesive fully cures, typically 24 hours or as indicated by the adhesive manufacturer. This solution is recommended where the installation may be cut on site and/or seamed for a wall to wall-floor to ceiling installation.

**VersaPRO installation surfaces require specific installation surface conditions be met.**

See installation instructions and videos online at [www.egan.com](http://www.egan.com). The manufacturer is not responsible for installation.

## VERSAPRO CRATE

400' roll freely spools material from the crate. Front edge of crate has a protective edge to reduce abrasions to the material. Self skidded for easy movement with lift truck.

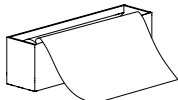

Code	Description	Dimension	Price/Ft.	Price/Roll
VPC20054	1/2 roll of VersaPRO	48"h or 54"h x 200'	\$75	\$15 000
VPC40054	1 roll of VersaPRO	48"h or 54"h x 400'	\$70	\$28 000
VPC40054	2 rolls of VersaPRO	48"h or 54"h x 400'	\$67	\$26 800
VPC40054	3+ rolls of VersaPRO	48"h or 54"h x 400'+	\$65	\$26 000

### Don't Forget the Versa Caddy

The height-adjustable Versa Caddy carries the weight of a VersaPRO roll, saves on labor costs and reduces the risk of damage

Code	Description	Price
VP-CADDY	Versa Caddy	\$590

# Upper Track Options

EganSystem offers track components for optimum communication flexibility and simplicity all in one product line. The discreet linear track is wall mounted at 81" high. EganSystem components are then easily suspended from the track. End caps are included. EganSystem Upper Track is designed to work with a wide variety of track mounted products including markerboards, tackboards, shelving and cabinets.

## SYSTEM TRACK - ST

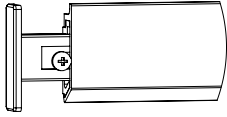

Code	Description	Dimensions	Price
<b>EMST96</b>	SystemTrack. Includes end caps (EMTSEC). EganMetallic (EM).	96" (8ft.) lengths	\$150
<b>ESST96CL</b>	SystemTrack. Includes end caps (ACTSECCL). Charcoal (CL).	96" (8ft.) lengths	\$150
<b>ESST96PY</b>	SystemTrack. Includes end caps (ACTSECPY). Putty (PY).	96" (8ft.) lengths	\$150
<b>EMTSEC</b>	End Caps for SystemTrack. 1 pair. EganMetallic (EM).		\$10
<b>ACTSECCL</b>	End Caps for SystemTrack. 1 pair. Charcoal (CL).		\$10
<b>ACTSECPY</b>	End Caps for SystemTrack. 1 pair. Putty (PY).		\$10

- Egan SystemTrack can be field cut and butt-joined to desired length

## GRIP TRACK - GT

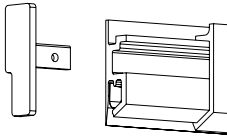

Code	Description	Dimensions	Price
<b>EMGT96</b>	GripTrack. Includes end caps (EMTSECG). EganMetallic (EM).	96" (8ft.) lengths	\$210
<b>ESGT96CL</b>	GripTrack. Includes end caps (ACTSECGCL). Charcoal (CL).	96" (8ft.) lengths	\$210
<b>ESGT96PY</b>	GripTrack. Includes end caps (ACTSECGPY). Putty (PY).	96" (8ft.) lengths	\$210
<b>EMTSECG</b>	End Caps for GripTrack. 1 pair. EganMetallic (EM).		\$40
<b>ACTSECGCL</b>	End Caps for GripTrack. 1 pair. Charcoal (CL).		\$40
<b>ACTSECGPY</b>	End Caps for GripTrack. 1 pair. Putty (PY).		\$40

- A built-in paper holder is integrated into the mounting extrusion of the track to suspend flipchart sheets directly from the track
- Egan GripTrack can be field cut and butt-joined to desired length

## TACK RAIL - ESTR

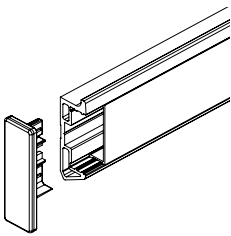

Code	Description	Infill: Tackable Material	Infill: Cork
<b>ESTR96</b>	96"w Tack Rail with tackable infill. Clear Anodized (CA) aluminum rail finish. 1/4" tackable strip depth. Includes end caps (ACTSECTREM).	\$230	\$230
<b>ACTSECTREM</b>	End Caps for Tack Rail. 1 pair. EganMetallic (EM).	\$10	

## 2. INFILL CASING

Code	Description
<b>EM</b>	EganMetallic
<b>CL</b>	Charcoal

## INFILL OPTIONS

Code	Description
<b>T1</b>	Charcoal, Tackable Material
<b>K</b>	Natural Cork

## HOW TO ORDER

# ESTR 96 EM T1

1. Product Code      Width      2. Infill Casing Color      3. Infill Option



# Upper Track Options

Egan Tack Rail presents the opportunity to specify a tackable rail infill, permitting you to affix maps, photos, memos and more. This allows materials to be attached to the rail with the use of pins or tacks. A variety of tackable material colors are available as infill options or infill can also be installed in a convex orientation for a smooth, non-tackable finish.

## TWIN TRACK - TT

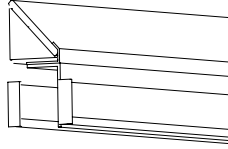

Code	Description	Dimensions	Price
<b>EMTT120</b>	TwinTrack. Includes end caps in EganMetallic (EM).	120" (10ft.) lengths	\$1,170
<b>ESTT120CL</b>	TwinTrack. Includes end caps in Charcoal (CL).	120" (10ft.) lengths	\$1,170
<b>ESTT120PY</b>	TwinTrack. Includes end caps in Putty (PY).	120" (10ft.) lengths	\$1,170

- One track is mounted to the wall and one additional tracks are mounted on the TwinTrack assembly
- Ships with five (5) clear, impact-resistant bumper guides that attach to the bottom frame of the boards to act as a spacer. When optional EganSystem boards are lined up in front of each other, the spacer prevents movement when using the front panel
- These products are not compatible with MultiTrack due to size restrictions: EVPR, ESR, EMTBFC, ESSH, ESOC, EMSCR, ASCRTSRPS
- Egan TwinTrack may be factory cut to specific lengths. Contact Egan Sales.

## MULTI TRACK - MT

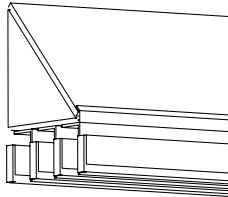

Code	Description	Dimensions	Price
<b>EMMT120</b>	MultiTrack. Includes end caps in EganMetallic (EM).	120" (10ft.) lengths	\$1,820
<b>ESMT120CL</b>	MultiTrack. Includes end caps in Charcoal (CL).	120" (10ft.) lengths	\$1,820
<b>ESMT120PY</b>	MultiTrack. Includes end caps in Putty (PY).	120" (10ft.) lengths	\$1,820

- One track is mounted to the wall and three additional tracks are mounted on the MultiTrack assembly
- Ships with nine (9) clear, impact-resistant bumper guides that attach to the bottom frame of the boards to act as a spacer. When optional EganSystem boards are lined up in front of each other, the spacer prevents movement when using the front panel
- These products are not compatible with MultiTrack due to size restrictions: EVPR, ESR, EMTBFC, ESSH, ESOC, EMSCR, ASCRTSRPS
- Egan MultiTrack may be factory cut to specific lengths. Contact Egan Sales.

## VERSA TRIM - EWVT



EganSystem Track is an ideal frame for VersaPRO presentation surface installations. Horizontal runs of EganSystem Track install top and bottom and are complimented by vertical trim on the sides to complete the frame. Egan also encourages properly installed third party framing to match the existing décor.

Code	Description	Price
<b>EWVT54</b>	60" vertical trim for use with EganSystem Upper Track options. Left/right pair. EganMetallic (EM). Field cut for 48" installations. An ideal frame for VersaPRO.	\$ 150

# Lower Track Options

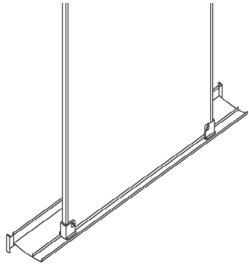

Typically mounted at 29”h from the floor, an EganSystem Lower Track can support a variety of functional accessories. The Versa Presentation Rail (EVPR) is a handy lower-track solution designed to support presentation material including VersaBoard and EganSystem Boards, sold separately. A Reference Shelf (ESR) can be positioned at any location along the lower track to hold reference material. Also available as an **accessory to existing track installations**.



Description	Price
36”w x 5”d Presentation Rail complete with Track. Clear Anodized (CA) finish.	\$ 190
36”w x 5”d Presentation Rail only. Clear Anodized (CA) finish.	\$ 140
48”w x 5”d Presentation Rail complete with Track. Clear Anodized (CA) finish.	\$ 230
48”w x 5”d Presentation Rail only. Clear Anodized (CA) finish.	\$ 160
60”w x 5”d Presentation Rail complete with Track. Clear Anodized (CA) finish.	\$ 260
60”w x 5”d Presentation Rail only. Clear Anodized (CA) finish.	\$210

Custom sizes available - Select next larger size and add \$150 to list / item

## 1. PRODUCT CODE

Code	Description
<b>EVPR</b> 	Versa Presentation Rail with Track
<b>EVPK</b> 	Versa Presentation Rail only

## WHAT'S IN THE BOX

Two (2) assorted color Dry-Erase Markers  
One (1) EganCloth

## HOW TO ORDER

**EVPR 36**

1. Product Code      Width

# Markerboards & Tackboards

EganSystem 202 track-mounted markerboards and tackboards feature unique, adjustable corner mounts that slide on and off. This design permits boards to reconfigure easily - hang them in any orientation. Finished in EganMetallic to match the 202 Collection. Available with EVS™ or Porcelain surfaces.

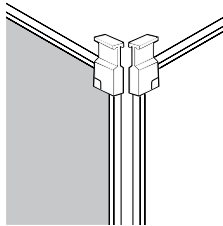
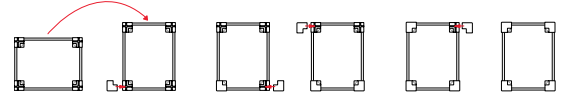

	EVS / EVS	EVS / Fabric	EVS / Grade A	EVS / Cork	Porcelain / Porcelain	Porcelain / Fabric	Porcelain / Grade A	Porcelain / Cork
26" w x 48" h	\$570	\$630	\$740	\$740	-	-	-	-
36" w x 48" h	\$750	\$830	\$910	\$910	\$860	\$940	\$1,050	\$1,050
60" w x 48" h*	\$980*	-	-	-	\$1,060*	-	-	-
26" w x 54" h	\$590	\$650	\$760	\$760	-	-	-	-
36" w x 54" h	\$790	\$870	\$980	\$980	-	-	-	-

Table indicates price for 2 sides. Eg. Side 1: EVS / Side 2: Fabric.

\*60x48 is not 2 sided and only specified with one side - EVS or Porcelain

Custom sizes available - Select next larger size and add \$250 to list / item

Custom Fabric Upcharge: \$150 List handling fee. Customer required to purchase fabric - COM (customer's own material).

EVS and Porcelain can not be specified in a combination together | Porcelain surface is not EganINK compatible  
EVS and Porcelain may be specified as magnet compatible

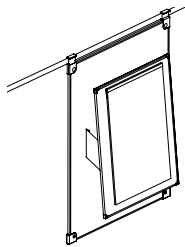

Flipchart Dimensions	EVS	Porcelain
Permanently mounted to a 36" w x 48" h	\$1,530	\$1,560

Track mounting flipchart holds a 27" w x 34" h flipchart pad. One (1) flipchart pad included

## 1. PRODUCT CODE

Code	Description
EETB	Markerboard EVS
EMTB	Markerboard Porcelain
EETBFC	Flipchart EVS
EMTBFC	Flipchart Porcelain

## 2. SURFACES

Code	Description
EE	Side 1: EVS / Side 2: EVS
EF	Side 1: EVS / Side 2: Fabric or Cork

For a full list of Standard and Grade A fabric options, visit [egan.com/fabrics-and-textiles/](http://egan.com/fabrics-and-textiles/)

## FINISHES

Code	Description	Price
EM	EganMetallic	\$0
PY	Putty	\$0
CL	Charcoal	\$0
CC	Custom Color	\$250

## EGANINK

Specify EganINK on EVS. Please reach to [our team](#) for an [EganINK](#) quote with your custom art file.

## HOW TO ORDER

**EMTB 36 48 EF | \_\_\_\_\_**

1. Product Code      Width      Height      2. Surface      EganINK File supplied by Egan

## WHAT'S IN THE BOX

For dry-erase surfaces, two (2) assorted color Dry-Erase Markers, and one (1) EganCloth

# Lightweight: VersaBoard

The most effective and versatile whiteboard in the world. The EVS™ surface hangs portrait or switches to landscape in seconds, with mounting options to suit every need. Incredibly lightweight, weighing as little as 3 1/2 lbs. Egan VersaBoard is reversible, offering double the work surface - and guaranteed-to-clean!

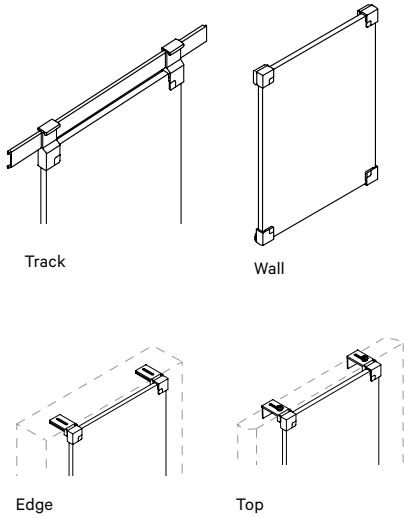
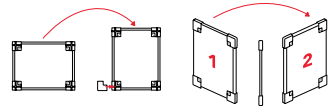

### 1 Board

Dimensions	Track Mount	Wall Mount	Edge Mount	Top Mount
26" w x 36" h	\$440	\$440	\$440	\$440
36" w x 48" h	\$730	\$730	\$730	\$730

### 3 Board Bundle - Save up to \$147/ Board

Dimensions	Track Mount	Wall Mount	Edge Mount	Top Mount
26" w x 36" h	\$980	\$980	\$980	\$980
36" w x 48" h	\$1,750	\$1,750	\$1,750	\$1,750

### 5 Board Bundle - Save up to \$200/ Board

Dimensions	Track Mount	Wall Mount	Edge Mount	Top Mount
26" w x 36" h	\$1,600	\$1,600	\$1,600	\$1,600
36" w x 48" h	\$2,640	\$2,640	\$2,640	\$2,640

\* Track Corner Mounts are compatible with Egan Wall System boards

## 1. PRODUCT CODE

Code	Description
<b>EVB</b>	Lightweight VersaBoard

## 2. MOUNT

Code	Description
<b>W</b>	Wall Mount
<b>E</b>	Edge Mount
<b>T</b>	Track Mount
<b>PA</b>	Top Mount - Narrow - 2"d to 3 3/16"d
<b>PB</b>	Top Mount - Medium - 3 3/16"d to 4 7/16"d
<b>PC</b>	Top Mount - Large - 4 7/16"d to 5 5/8"d

## 3. QUANTITY

Code	Description
<b>1</b>	1 Board
<b>3</b>	3 Board Bundle
<b>5</b>	5 Board Bundle

## HOW TO ORDER

**EVB 36 48 PA 5 |**

1. Product Code    Width    Height    2. Mount    3. Qty    EganINK File supplied by Egan

## WHAT'S IN THE BOX

Ships with specified mount  
For dry-erase surfaces, two (2) assorted color Dry-Erase Markers, and one (1) EganCloth

# Lightweight: VersaBoard

VersaBoard ships with mounts specified. For added functionality and versatility, optional mount kits are available below.

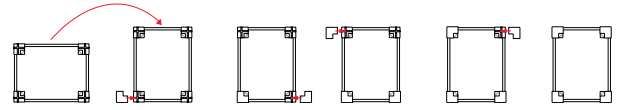

## Additional VersaBoard Mount Kits

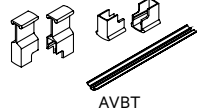
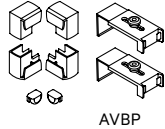
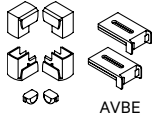
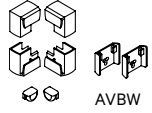

Track Mount	Dimensions	Description	Price
AVBT	N/A	Two Track corner mounts, two Track bumpers. Board not included. Compatible with Egan VersaBoards. Required for Glass (AVBG) and Magnetic Mount Kits (AVBM), wing bumper. Finished in EganMetallic (EM).	\$50

Wall Mount	Dimensions	Description	Price
AVBW	N/A	Two left and two right corner mounts, two rubber standoffs, two wall mount brackets. Restricted to 6 lb. max. weight load. VersaBoard not included. Finished in EganMetallic (EM).	\$50

Edge Mount	Dimensions	Description	Price
AVBE	N/A	Two left and two right corner mounts, two rubber standoffs, two edge mount brackets. Restricted to 6 lb. max. weight load. VersaBoard not included. Finished in EganMetallic (EM).	\$50

Top Mount	Dimensions	Description	Price
AVBPA	2" to 3 3/16"	Two left and two right corner mounts, two rubber standoffs, two Top Mount assemblies. Specify size as per code. Restricted to 6 lb. max weight load. VersaBoard not included. Finished in EganMetallic (EM).	\$80
AVBPB	3 3/16" to 4 7/16"		\$80
AVBPC	4 7/16" to 5 5/8"		\$80

## VersaBoard Track Kits (EVB)

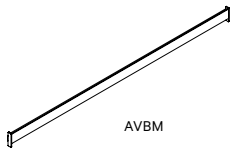
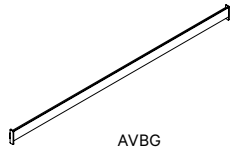

For lightweight VersaBoards only. Not compatible with EganSystem or EganSystem Office.

Adhesive-backed EganMetallic (EM) SystemTrack designed to support lightweight VersaBoards on glass windows, walls, or any smooth surface that will not accommodate a fastener. VersaBoard not included. EganSystem 202 and EganSystem Office products are too heavy for this application. For this type of installation, VersaBoard must be specified with Track Mount (AVBT) corners.

Glass Mount	Dimension	Price
AVBG37	37" lengths	\$100
AVBG49	49" lengths	\$120

Magnetic backed 37" and 49" lengths of EganMetallic (EM) SystemTrack designed to support lightweight VersaBoards on metal-surfaced panel systems, partitions or file cabinets. VersaBoard not included. EVS and EganBoard Porcelain system boards are too heavy for this application. For this type of installation, VersaBoard must be specified with Track Mount (AVBT) corners.

Magnetic Mount	Dimension	Price
AVBM37	37" lengths	\$120
AVBM49	49" lengths	\$150

Note: These two unusual track options are designed for use with lightweight Track Mount VersaBoards ONLY and are restricted to a maximum 7 lb weight load. EganSystem 202 and EganSystem Office products are too heavy for this application

# Shelving

EganSystem Office Shelving is a unique track solution designed with a continuous track hanger that runs across the width of the product to evenly distribute weight to safely support the shelves and cabinets. The hanger slides easily across the track for quick, simple re-configuration.

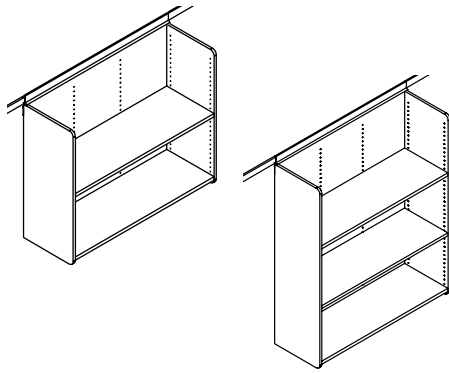

Dimensions	Price	Notes	
One fixed shelf (not shown)			
36" w x 16" h x 12 1/2" d	\$680	<ul style="list-style-type: none"> <li>• Shelves adjustable on 1 1/4" centers, bottom shelf fixed</li> <li>• Supported from recommended 81" high SystemTrack or GripTrack</li> <li>• Shelves can be repositioned anywhere along the track</li> <li>• Orders for under six (6) units are shipped 'knocked-down', assembly required</li> </ul>	
42" w x 16" h x 12 1/2" d	\$720		
48" w x 16" h x 12 1/2" d	\$790		
One fixed, one adjustable shelf			
36" w x 29" h x 12 1/2" d	\$820		
42" w x 29" h x 12 1/2" d	\$860		
48" w x 29" h x 12 1/2" d	\$930		
One fixed, two adjustable shelves			
36" w x 43" h x 12 1/2" d	\$980		
42" w x 43" h x 12 1/2" d	\$1,020		
48" w x 43" h x 12 1/2" d	\$1,090		

Custom sizes available - Select next larger size and add \$250 to list / item

## 1. PRODUCT CODE

Code	Description
<b>ESSH</b>	EganSystem Office Shelf

## 2. SHELVES

Code	Description
<b>1</b>	1 Fixed Shelf
<b>2</b>	1 Fixed, 1 Adjustable Shelf
<b>3</b>	1 Fixed, 2 Adjustable Shelves

## 3. SHELF FINISH

EganMetallic	Black	Charcoal	Gray	Platinum	Putty	Sand	Slate	Taupe
EM	BL	CL	GR	PT	PY	SN	SL	TA

## HOW TO ORDER

**ESSH 42 2 PT**

1. Product Code
Width
2. Shelves
3. Shelf Finish

# Cabinets

EganSystem Office Shelf Cabinets are designed with a continuous track hanger that runs across the width of the product to evenly distribute weight to safely support the shelves and cabinets. The hanger slides easily across the track for quick, simple re-configuration. The entire line is ideal for office environments, providing utility on the wall, without compromising floor space. With GripTrack and Security Locks, shelves are prevented from unwanted movement. 60lbs per shelf capacity.

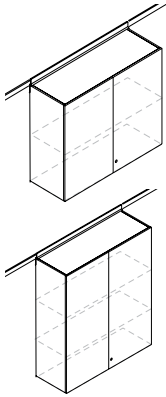

Dimensions	Etex	Wood Veneer <sup>1</sup>
<b>One fixed, one adjustable shelf, two doors</b>		
36" w x 29" h x 12 1/2" d	\$1,180	\$1,450
<b>One fixed, two adjustable shelves, two doors</b>		
36" w x 43" h x 12 1/2" d	\$1,380	\$1,650

Custom sizes available - Select next larger size and add \$250 to list / item

<sup>1</sup> Available on doors only

- Shelves adjustable on 1 1/4" centers, bottom shelf fixed. Honeycomb substrate doors have three-way adjustable hinges
- Cabinet Lock included. Key is packaged, taped to the bottom shelf of the cabinet

EganMetallic	Black	Charcoal	Gray	Platinum	Putty	Sand	Slate	Taupe
EM	BL	CL	GR	PT	PY	SN	SL	TA

## 1. PRODUCT CODE

Code	Description
<b>ESOC</b>	EganSystem Office Cabinet

## 2. TOTAL SHELVES

Code	Description
<b>2</b>	1 Fixed Shelf
<b>3</b>	1 Fixes, 1 Adjustable Shelf, 2 Doors

## 3. FINISH

Wood Veneer Stains: Doors Only	
Code	Description
<b>LO</b>	Light Oak
<b>MO</b>	Medium Oak
<b>DO</b>	Dark Oak
<b>BO</b>	Black Oak
<b>MA</b>	Mahogany
<b>CH</b>	Cherry
<b>MP</b>	Natural Maple
<b>WA</b>	Walnut
Custom Stain (Code: CS) available Add \$300 to list, per item	

Etex Color Options: Body/ Shelf & Doors	
Code	Description
<b>EM</b>	EganMetallic
<b>BL</b>	Black
<b>CL</b>	Charcoal
<b>GR</b>	Gray
<b>PT</b>	Platinum
<b>PY</b>	Putty
<b>SN</b>	Sand
<b>SL</b>	Slate
<b>TA</b>	Taupe
Custom Color (Code: CC) available Add \$250 to list, per item	

## HOW TO ORDER

# ESOC 36 2 EM MP

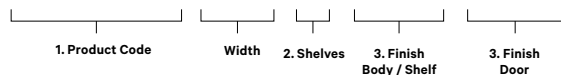

# VersaJOT

Designed for quick and easy installation, this amazing pressure sensitive adhesive, dry-erase product applies to most finished surfaces in seconds. VersaJOT is offered in units precisely cut to Customer's Own Art patterns (COA). VersaJOT pieces are custom-shape, precision CNC cut from a 54" wide roll on an 84" long bed, and are applied with high-adhesive glue. Volume pricing is available.

## Specifying VersaJOT

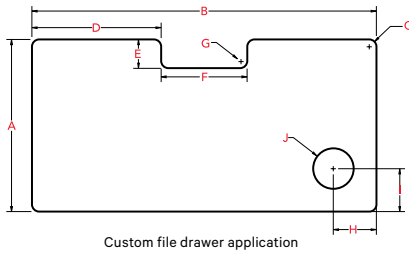

- A. Height
- B. Width
- C. Corner Radius\*\*
- D. Notch Inset Horizontal
- E. Notch Inset Vertical
- F. Notch Width
- G. Notch Corner Radius\*\*
- H. Knock-out Inset Horizontal
- I. Knock-out Inset Vertical
- J. Knock-out Diameter

VersaJOT is cut to your specifications for your custom requirement. Exact measurements are required.

\*\* 1/4" radius corners are standard unless specified otherwise. Minimum radius corner is 1/8"

Egan Visual is pleased to accept COA patterns prepared in suitable vector file formats: AutoCad (DWG or DXF), Adobe Illustrator (EPS or AI), Corel Draw (EPS or CDR) to Encapsulated Postscript (EPS). Egan Visual will execute designs exactly as provided. Suitable vector files contain mathematical shapes. Embedding or "copying-and-pasting" a raster image such as a BMP, PSD, JPG, GIF, or PNG into a vector file is not suitable and will be subject to engineering charges. All VersaJOT orders are customized. Egan Visual does not accept responsibility for errors in customer instructions. Submitting a purchase order with a suitable vector file for VersaJOT release Egan Visual from responsibility for specification errors discovered upon installation.

## VersaJOT (VJ)

VersaJOT is cut from a 54"w roll and is offered on a linear foot basis. For an accurate quote, call Egan Inside Sales

LFT	Price/LFT	EganINK/LFT
7-49	\$120	\$200
50-99	\$110	\$190
100+	\$100	\$180

• 7 linear feet is the minimum order size

## How To Order:

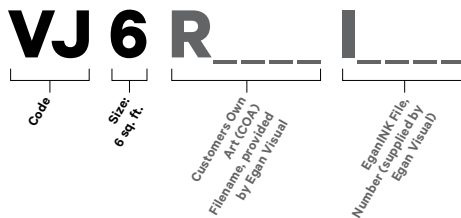

## Installation Guidelines for VersaMAG and VersaJOT

### A. INCORRECT



### B. CORRECT



**Edge Overhang:**  
Measure VersaMAG/ VersaJOT to inset especially on rounded corners. Example "A" will cause VersaJOT to peel off. Example "B" is a good inset from the edge.

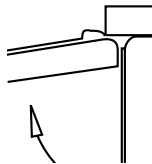

**Clearance Required:**  
Allow for clearance on moving surfaces. The hutch door in this example does not have enough clearance (1/16"), causing an obstruction at the hinge area.

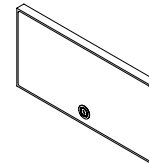

Specify VersaJOT with a 1/8" inset around edges and locks to ensure a good fit. VersaMAG is NOT available with notches or cut outs.

## What's in the box:

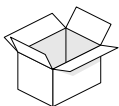

• Ships with two (2) assorted color Dry-Erase Markers and one (1) EganCloth. Contingent upon standard size cut sheets.

## Product notes:

- One knock-out shape provided at no charge. Additional knock-outs, add \$150 per sized pattern. Upcharge applies once per drawing when number of knock-outs are 2 or more on that same drawing
- Engineering charges of \$150 minimum will be applied to orders with incorrect file format
- Maximum dimensions are 54" x 84". VersaJOT has a thickness of 0.050". Minimum corner radius 1/8". Egan guarantees +/- 1/16" accuracy overall
- Square footage to be taken from gross material requirement for final pattern
- A self adhesive or magnetic marker tray (ACEOT) is available.
- Add 1" to both Width and Height when specifying EganINK square footage



# VersaMAG

VersaMAG is EVS applied to a magnet. It installs magnetically on any metal surface, and is offered in popular sizes or as custom shaped up to a maximum of 84" x 48". VersaMAG is ideal for smaller locations where a metal surface can be upgraded for dry-erase use. EganINK™ adds branding and increases functionality.

### VersaMAG Run Standard (SM)

- 15" height features 1/4" eased corner detail to fit a variety of applications.



- 18" height features 1/4" eased corner detail to fit a variety of applications.



Code	Description	Price
SM2415-10	10 pieces magnetic mount 24"w x 15"h	\$580
SM2418-10	10 pieces magnetic mount 24"w x 18"h	\$780
SM3015-10	10 pieces magnetic mount 30"w x 15"h	\$710
SM3018-10	10 pieces magnetic mount 30"w x 18"h	\$950
SM3615-10	10 pieces magnetic mount 36"w x 15"h	\$830
SM3618-10	10 pieces magnetic mount 36"w x 18"h	\$1,110
SM4215-10	10 pieces magnetic mount 42"w x 15"h	\$950
SM4218-10	10 pieces magnetic mount 42"w x 18"h	\$1,280

### How To Order:



\* Not available in single units

### VersaMAG Run Custom (VM)

VersaMAG is cut from a 48"w roll and is offered on a linear foot basis. For an accurate quote, call Egan Inside Sales.

LFT	Price/LFT	EganINK/LFT
7-49	\$130	\$210
50-99	\$120	\$200
100+	\$100	\$200

- 7 linear feet is the minimum order size

### How To Order:

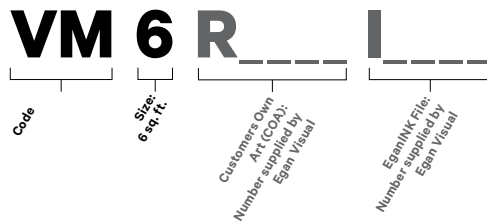

### What's in the box:

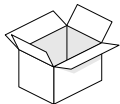

- Ships with two (2) assorted color Dry-Erase Markers and one (1) EganCloth. Contingent upon standard size cut sheets.

### Product notes:

- Engineering charges of \$150 minimum will be applied to orders with incorrect file format
- VersaMAG has a thickness of 0.075". Minimum corner radius 1/8". Egan guarantees ± 1/16" accuracy overall
- Square footage to be taken from gross material requirement for final pattern
- A self adhesive or magnetic marker tray (ACEOT) is available
- Add 1" to both Width and Height when specifying EganINK square footage
- For irregular shapes, cutouts, or notches contact Egan Inside Sales

## Egan Cabinets

### ■ Classic Egan Etex Cabinet

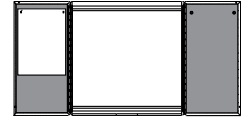

CAPX, CEXB, CABX

Choose high-performance EVS™ or Porcelain, housed in a full featured Etex Color Cabinet. Etex coatings are impregnated with polystyrene particles, providing a very durable finish. Etex has a slight texture, hides fingerprints, and is easily maintained. Cabinet interiors are equipped with tackable EganFabric panel(s) and a flipchart with tearbar which may be suspended from either door.

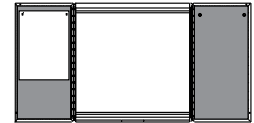

CEWR, CARW, CEWB, CABW, CEWT, CATW

### ■ Classic Egan Wood Cabinet

Choose high-performance EVS™ surface or Porcelain, housed in a finely crafted wood cabinet. Hand selected, solid hardwoods and veneers in the species of your choice. Face veneers are book matched and laid up to beautifully reveal the wood's best characteristics. Cabinet interiors are equipped with tackable EganFabric panel(s) and a flipchart with tearbar which may be suspended from either door.

### ■ Dimension Cabinet



Dimension Cabinet, formerly known as the Versa Cabinet, is a redesign of the original Presentation Cabinet that Egan Visual introduced over 40 years ago. Designed to handle modern applications like data projection, this product also meets the highest design aesthetics. Featuring EVS™ in 77" w x 48" h (16:10 format) or 60" w x 48" h and 48" w x 42" h sizes for dry-erase and projection applications. Cabinet interiors are equipped with tackable EganFabric panel(s) and a flipchart with tearbar which may be suspended from either door. Offered with Wood/Custom Stain or Etex/Custom Color doors.

### ■ Boxcore Cabinets



Boxcore Cabinets utilizes the VersaCabinet body and offers increased functionality and a modern design aesthetic with new front-of-cabinet surface options for additional work space, tacked notes, or even custom graphics. Door front infill can be specified in EVS™ (magnet-compatible), Tackable Fabric, GlassWrite. The body of the cabinet shows Boxcore frame, and features an EVS dry-erase guaranteed-to-clean writing surface, also magnet and projection compatible. Egan Boxcore technology brings crisp edge definition and durability, emphasizing the cabinet's clean lines and modern appearance.

# Classic | Egan Etex Cabinet

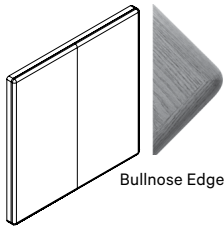

	Center Panel EVS		Center Panel Porcelain	
	Interior Door Standard Fabric	Interior Door Grade A Fabric	Interior Door Standard Fabric	Interior Door Grade A Fabric
24"w x 36"h	\$1,600	\$1,750	\$1,710	\$1,860
48"w x 32"h	\$2,410	\$2,560	\$2,570	\$2,720
48"w x 48"h	\$2,890	\$3,080	\$3,210	\$3,400
72"w x 48"h	\$3,850	\$4,040	\$4,230	\$4,420

24x36 model has only one door that mounts to open left or right | Porcelain is not EganINK Compatible Custom Fabric COM (customer's own material) Upcharge: \$150 List handling fee. Customer required to purchase fabric

Presentation Cabinets

## 1. PRODUCT CODE

Code	Description
<b>CEXB</b>	Bullnose   EVS
<b>CABX</b>	Bullnose   Porcelain

## 3. FINISH

Code	Description
<b>EM</b>	EganMetallic
<b>BL</b>	Black
<b>CL</b>	Charcoal
<b>GR</b>	Gray
<b>PT</b>	Platinum
<b>PY</b>	Putty
<b>SN</b>	Sand
<b>SL</b>	Slate
<b>TA</b>	Taupe
Custom Color Add \$ 250 to list, per item	

## 2. SIZES

Code	Sizes
<b>24</b>	24"w x 36"h
<b>32</b>	48"w x 32"h
<b>48</b>	48"w x 48"h
<b>72</b>	72"w x 48"h

## OPTIONS

Code	Option	Sizes	Price	Description
<b>F</b>	Flipchart	32 48 72	\$100	2nd flipchart with tearbar. The 2nd flipchart is not available on 24"w (24) cabinets.
<b>L</b>	Lock	ALL	\$130	Security lock.
<b>D</b>	Writing Surface Door Inserts	24 32 48 72	\$160 \$250 \$300 \$390	Porcelain or EVS to match surface specified for base cabinet. Flipcharts not available with this option. Not available for Rectilinear Edge Etex Cabinet (CAPX and non-boxcore CE2). Option available only when specified on both doors.

## EGAN INK

Specify EganINK on EVS. Please reach to [our team](#) for an [EganINK](#) quote with your custom art file.

## WHAT'S IN THE BOX

Ships with specified mount  
Two (2) assorted color Dry-Erase Markers  
One (1) EganCloth

## HOW TO ORDER

**CEXB 48 EM LF I \_\_\_\_\_**

1. Product Code
2. Size
3. Finish
Option
EganINK

# Classic | Egan Wood Cabinet

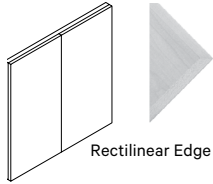

	EVS Center Panel		Porcelain Center Panel	
	Tack Panel Standard Fabric	Tack Panel Grade A	Tack Panel Standard Fabric	Tack Panel Grade A
24"w x 36"h	\$1,890	\$2,040	\$2,020	\$2,170
48"w x 32"h	\$2,700	\$2,850	\$2,630	\$2,780
48"w x 48"h	\$3,460	\$3,650	\$3,820	\$4,010
72"w x 48"h	\$4,550	\$4,740	\$5,000	\$5,190

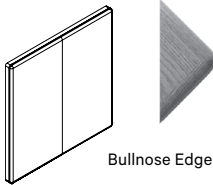

	EVS Center Panel		Porcelain Center Panel	
	Tack Panel Standard Fabric	Tack Panel Grade A	Tack Panel Standard Fabric	Tack Panel Grade A
24"w x 36"h	\$2,070	\$2,220	\$1,880	\$2,030
48"w x 32"h	\$3,310	\$3,460	\$2,830	\$2,980
48"w x 48"h	\$3,770	\$3,960	\$3,540	\$3,730
72"w x 48"h	\$4,950	\$5,140	\$4,650	\$4,840

## 1. PRODUCT CODE

Code	Description
<b>CEWR</b>	Rectilinear   EVS
<b>CARW</b>	Rectilinear   Porcelain
<b>CEWB</b>	Bullnose   EVS
<b>CABW</b>	Bullnose   Porcelain

## 2. SIZES

Code	Sizes
<b>24</b>	24"w x 36"h
<b>32</b>	48"w x 32"h
<b>48</b>	48"w x 48"h
<b>72</b>	72"w x 48"h

## 3. FINISH/VENEER

Code	Description
<b>LO</b>	Light Oak
<b>MO</b>	Medium Oak
<b>DO</b>	Dark Oak
<b>BO</b>	Black Oak
<b>MA</b>	Mahogany
<b>CH</b>	Cherry
<b>MP</b>	Natural Maple
<b>WA</b>	Walnut
Custom Stain available. Add \$300 to list, per item.	

## OPTIONS

Code	Option	Sizes	Price	Description
<b>F</b>	Flipchart	32   48   72	\$100	2nd flipchart with tearbar. The 2nd flipchart is not available on 24"w cabinets.
<b>L</b>	Lock	ALL	\$130	Security lock.
<b>D</b>	Writing Surface Door Inserts	24	\$160	EganBoard Porcelain or EVS to match surface specified for base cabinet. Flipcharts not available with this option. Not available for Rectilinear Edge Etex Cabinet (CAPX and non-boxcore CE2). Option available only when specified on both doors.
		32	\$250	
		48	\$300	
		72	\$390	
Custom Logo			Inquire*	

## HOW TO ORDER

**CEWB 48 CH LF**

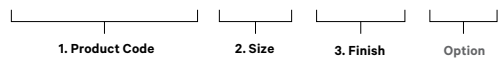

**CEWB 48 CH E\_\_\_ LF**

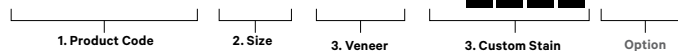

# Dimension Cabinet

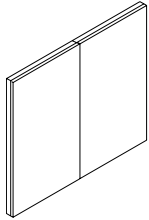

	Door Etex		Door Wood Veneer	
	Interior Door Standard Fabric	Interior Door Grade A Fabric	Interior Door Standard Fabric	Interior Door Grade A Fabric
48" w x 42" h	\$2,290	\$2,510	\$3,340	\$3,560
60" w x 48" h	\$2,550	\$2,770	\$3,600	\$3,820
77" w x 48" h*	\$3,260	\$3,480	\$4,310	\$4,530

\* Optimized for projection aspect ratio | Interior Doors: Cork and EVS not available  
COM (customer's own material) Upcharge: \$150 List handling fee. Customer required to purchase fabric

### 1. PRODUCT CODE

Code	Description
CE2	Dimension Cabinet   EVS

### 2. BODY FINISH

Code	Description
A	Clear Anodized
B	Black Anodized

### 3. DOOR FINISH

Etex Color Options: Doors Only	
Code	Description
EM	EganMetallic
BL	Black
CL	Charcoal
GR	Gray
PT	Platinum
PY	Putty
SN	Sand
SL	Slate
TA	Taupe
Custom Color available Add \$250 to list, per item	

Wood Veneer Stains: Doors Only	
Code	Description
LO	Light Oak
MO	Medium Oak
DO	Dark Oak
GO	Gray Oak
BO	Black Oak
MA	Mahogany
CH	Cherry
MP	Natural Maple
WA	Walnut
Custom Stain available Add \$300 to list, per item	

### OPTIONS

Code	Description	Price
F	2nd Flipchart with TearBar	\$100
L	Keyed Security Lock	\$130

### EGAN INK

Specify EganINK on EVS. Please reach to [our team](#) for an [EganINK](#) quote with your custom art file.

### WHAT'S IN THE BOX

Ships with specified mount  
Two (2) assorted color Dry-Erase Markers  
One (1) EganCloth

### HOW TO ORDER

**CE2 A 60 48 MP FL 463490-001 I**

1. Product Code    2. Body Finish    Width    Height    3. Door Finish    Option    Fabric    EganINK

For a full list of Standard and Grade A fabric options, visit [egan.com/fabrics-and-textiles/](https://egan.com/fabrics-and-textiles/)

# Boxcore Cabinet

Dimensions	EVS	GlassWriteMAG	Tack   EcoTack	Tack   Standard Fabric	Tack   Grade A Fabric
24" w x 36" h x 3" d	\$1,210	\$1,720	\$1,280	\$1,330	\$1,570
48" w x 42" h x 3" d	\$2,320	\$2,820	\$2,430	\$2,570	\$2,950
60" w x 48" h x 3" d	\$2,550	\$4,050	\$2,710	\$2,850	\$3,380
77" w x 48" h x 3" d	\$2,960	\$4,730	\$3,110	\$3,250	\$3,780

COM (customer's own material) Upcharge: \$150 List handling fee. Customer required to purchase fabric  
 24x36 model has only one door that mounts to open left or right  
 EVS surface is Magnet Compatible, GlassWrite MAG is NeoMagnet.

## 1. PRODUCT CODE

Code	Description
<b>CEEB</b>	Boxcore   EVS or Tack
<b>CEGMB</b>	Boxcore   GlassWrite

## 2. BODY FINISH

Code	Description
<b>A</b>	Clear Anodized
<b>B</b>	Black Anodized

## 3. DOOR FINISH

Door Front CEEB Finish Options

Code	Description	
<b>E</b>	EVS	
<b>F</b>	Fabric	For a full list of Standard and Grade A fabric options, visit <a href="http://egan.com/fabrics-and-textiles/">egan.com/fabrics-and-textiles/</a>

Door Interior

Code	Description
<b>E</b>	EVS

Door Front CEGMB Finish Options

Code	Description	
<b>WH</b>	Glass   White	
<b>IP</b>	Glass   Infinite Color Program	Visit <a href="http://egan.com">egan.com</a> or <a href="http://pantone.com">pantone.com</a> for colors. Backpainted glass only.
<b>CC</b>	Custom Color	

## EGAN INK

Specify EganINK on EVS or Glass. Please reach to [our team](#) for an [EganINK](#) quote with your custom art file.

## HOW TO ORDER

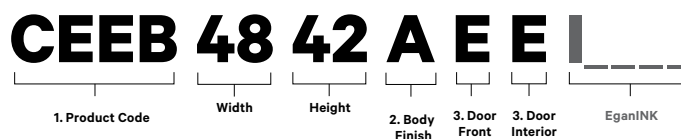

## WHAT'S IN THE BOX

Ships with specified mount  
 Two (2) assorted color Dry-Erase Markers  
 One (1) EganCloth

## Egan Mobiles

### ■ Architrave Mobile

Architrave products are defined by their sturdy, wood oak Boxcore 1 1/8" (29mm) frame. Features of the Architrave family consist of thin bezel edge of 1/4" (6mm), a robust construction with a clean external appearance and no extraneous materials. Specify Architrave mobile from a range of infill options, such as EVS, GlassWrite, EganINK, Tackable fabric or EcoTack/Polyethylene Terephthalate (PET).

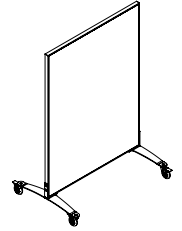

### ■ Boxcore Mobile

The Boxcore Mobile utilizes the unique Egan Boxcore™ design for a high degree of stability when moving and when writing. It is distinguished by an ultra-thin bezel, and aluminum frame in 1 1/8" (29mm) depth. The Boxcore Mobile has a new frame to base connection, for clean uninterrupted lines. This new connection provides additional functionality by linking together multiple Boxcore Mobiles on a linear plane with only a 1/4 gap between mobiles. Available with EVS, Glass and Tackable infills.

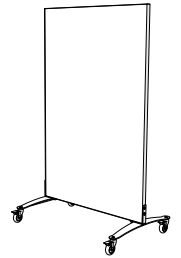

### ■ V-Series Mobile

V-Series Mobiles are available with Four-Point Base and Three-Point Bases. The V-Series Four-Point Base Mobiles are designed to link or stand alone, whereas, the Three-Point Base Mobiles are designed to work with Four-Point base models to create linked partitions that can be positioned at almost any angle. These Mobiles feature guaranteed-to-clean EVS™ dry-erase surface that accepts magnetic accessories. Three-Point Base models are not recommended for non-linked applications.

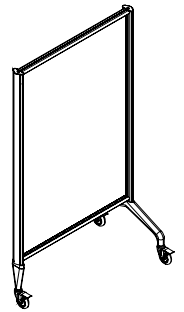

### ■ Egan Lite Mobile

Egan Lite Mobiles are incredibly lightweight and easy to move, base options include locking casters or a low profile bases to suit your application. The Lite Mobile is also available as a Screen Door - a weighted trip-free base with exceptional stability and rotation through 360°. A 90° notch in the base provides compatibility with any wall or partition system. The no-lock front caster rolls smoothly and ensures door will fold back to permit free traffic flow. Egan Lite Mobiles can be specified with an EVS or Tackable infill per side.

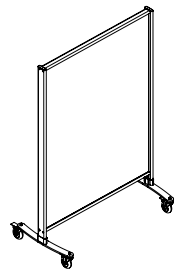

### ■ A-Frame VersaMobile

A-Frame VersaMobiles offer two-sided high-performance EVS™ dry-erase surface. Specify any combination of EVS™ magnetic surface or Egan tackable fabric. A fixed track at the top of the A-Frame accommodates lightweight VersaBoards or EganSystem Track boards. Additional VersaBoards or 202 EganSystem Boards sold separately. Storage for up to five boards is available inside the spacious A-Frame shelf cavity.

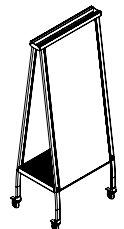

# Architrave Mobile

Architrave products are defined by their sturdy, wood oak Boxcore 1 1/8" (29mm) frame. Features of the Architrave family consist of thin bezel edge of 1/4" (6mm), a robust construction with a clean external appearance and no extraneous materials. Specify your Architrave mobile from a range of infill options, such as EVS, GlassWrite, EganINK, Tackable fabric (EganFabric or maharam), or EcoTack. Mobile bases come with easy swivel and locking casters.

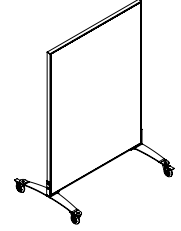

Architrave Mobiles can be specified with a different infill per side. Pricing reflects costs for 1 side only. Choose an infill for each side and add the price together for the total cost. If the infill is the same for both sides, simply double the cost in the chart below.

## Table Shows Pricing Per Side of Board

Dimensions	EVS/ per side	Tack EcoTack/ per side	Tack Standard Fabric/ per side	Tack Grade A Fabric/ per side
36" w x 54" h x 23 1/2" d	\$1,010	\$1,070	\$1,130	\$1,210
48" w x 54" h x 23 1/2" d	\$1,160	\$1,220	\$1,280	\$1,360
36" w x 60" h x 23 1/2" d	\$1,050	\$1,110	\$1,170	\$1,250
48" w x 60" h x 23 1/2" d	\$1,180	\$1,240	\$1,300	\$1,380
36" w x 72" h x 23 1/2" d	\$1,230	\$1,290	\$1,350	\$1,430
48" w x 72" h x 23 1/2" d	\$1,250	\$1,310	\$1,370	\$1,450

Table indicates price per side of board. ie. Cost of single side EVS is \$1,010, and 2 sided EVS is \$2,020  
 Custom sizes available - Please reach out to sales for a quote.  
 COM (customer's own material) Upcharge: \$150 List handling fee. Customer required to purchase fabric

### PRODUCT CODE

Code	Description
ARCM	EVS, EcoTack or Fabric

### 2. ARCM SURFACE

Code	Description
E	EVS
T	EcoTack/PET (EganMetallic Color)
F	Fabric
For a full list of Standard and Grade A fabric options, visit <a href="http://egan.com/fabrics-and-textiles/">egan.com/fabrics-and-textiles/</a>	

### 3. FRAME STAINS

Code	Description	Price
LO	Light Oak	\$ 0
MO	Medium Oak	\$ 0
DO	Dark Oak	\$ 0
BO	Black Oak	\$ 0
CS	Custom Stain	\$ 300

### 4. BASE COLOR

Code	Description	Price
EM	EganMetallic	\$ 0
WH	White	\$ 150
BL	Black	\$ 150
CC	Custom Color	\$ 250

### EGANINK

Specify EganINK on EVS. Please reach to [our team](#) for an [EganINK](#) quote with your custom art file.

### HOW TO ORDER

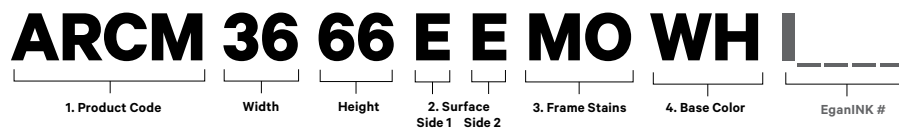

### WHAT'S IN THE BOX

For dry-erase surfaces, two (2) assorted color Dry-Erase Markers, and one (1) EganCloth



# Architrave Mobile GlassWrite

Architrave products are defined by their sturdy, wood oak Boxcore 1 1/8" (29mm) frame. Features of the Architrave family consist of thin bezel edge of 1/4" (6mm), a robust construction with a clean external appearance and no extraneous materials. Architrave mobile can be specified with GlassWrite infill on both sides. Mobile bases come with easy swivel and locking casters.

Egan GlassWrite is built from a guaranteed-to-clean, crystal clear, low iron tempered safety glass. GlassWrite surfaces are dry erase, guaranteed-to-clean board, neo-magnet compatible, and with color from Egan's infinite color program or high-resolution printing with EganINK.

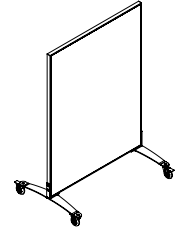

Dimensions	GlassWrite MAG
36"w x 54"h x 23 1/2"d	\$3,700
48"w x 54"h x 23 1/2"d	\$4,590
36"w x 60"h x 23 1/2"d	\$3,890
48"w x 60"h x 23 1/2"d	\$4,820
36"w x 72"h x 23 1/2"d	\$4,560
48"w x 72"h x 23 1/2"d	\$5,470

**GlassWrite MAG cannot be specified with other infills.**

Custom sizes available - Please reach out to sales for a quote.

PRODUCT CODE / SURFACE	Code	Description	2. GLASS COLOR	Code	Description	Price
	<b>ARCMGG</b>	GlassWrite MAG		<b>WH</b>	White	\$ 0
				<b>IP</b>	Infinite Color Program	\$ 0
				<b>CC</b>	Custom Color	\$ 250
Visit <a href="http://egan.com">egan.com</a> or <a href="http://pantone.com">pantone.com</a> for colors.						

3. FRAME STAINS	Code	Description	Price	4. BASE COLOR	Code	Description	Price
	<b>LO</b>	Light Oak	\$ 0		<b>EM</b>	EganMetallic	\$ 0
	<b>MO</b>	Medium Oak	\$ 0		<b>WH</b>	White	\$ 150
	<b>DO</b>	Dark Oak	\$ 0		<b>CC</b>	Custom Color	\$ 250
	<b>BO</b>	Black Oak	\$ 0				
	<b>CS</b>	Custom Stain	\$ 300				

**EGANINK** Specify EganINK on Glass. Please reach to [our team](#) for an [EganINK](#) quote with your custom art file.

**HOW TO ORDER**

**ARCM G G 36 66 WH MO WH I \_\_\_\_\_**

1. Product Code      1. Surface Side 1 Side 2      Width      Height      2. Glass Color      3. Frame Stains      4. Base Color      EganINK #

**WHAT'S IN THE BOX** Two (2) assorted color Dry-Erase Markers, and one (1) EganCloth

# Boxcore Mobile

The Boxcore Mobile utilizes the unique Egan Boxcore™ design for a high degree of stability when moving and when writing. It is distinguished by an ultra-thin bezel, and an aluminum frame in 1 1/8" (29mm) depth. The Boxcore Mobile has a new frame to base connection, for clean uninterrupted lines. This new connection provides additional functionality by linking together multiple Boxcore Mobiles on a linear plane with only a 1/4 gap between mobiles. Available with EVS, Glass and Tackable infills. Mobile bases come with easy swivel and locking casters.

Boxcore Mobiles can be specified with a different infill per side. Pricing reflects costs for 1 side only. Choose an infill for each side and add the price together for the total cost. If the infill is the same for both sides, simply double the cost in the chart below.

## Table Shows Pricing Per Side of Board

Dimensions	EVS/ per side	Tack EcoTack/ per side	Tack Standard Fabric/ per side	Tack Grade A Fabric/ per side
36"w x 54"h x 23 1/2"d	\$1,010	\$1,070	\$1,130	\$1,210
48"w x 54"h x 23 1/2"d	\$1,160	\$1,220	\$1,280	\$1,360
36"w x 60"h x 23 1/2"d	\$1,050	\$1,110	\$1,170	\$1,240
48"w x 60"h x 23 1/2"d	\$1,190	\$1,250	\$1,310	\$1,390
36"w x 72"h x 23 1/2"d	\$1,230	\$1,290	\$1,350	\$1,430
48"w x 72"h x 23 1/2"d	\$1,250	\$1,310	\$1,370	\$1,450

Table indicates price per side of board. ie. Cost of single side EVS is \$1,010, and 2 sided EVS is \$2,020  
 Custom sizes available - Please reach out to sales for a quote.  
 COM (customer's own material) Upcharge: \$150 List handling fee. Customer required to purchase fabric

### 1. PRODUCT CODE

Code	Description
VBD	EVS, Fabric, or EcoTack

### 2. SURFACE

Ensure surface for side 1 and side 2 is selected.

Code	Description
E	EVS
F	Fabric
T	EcoTack/PET (EganMetallic color)
For a full list of Standard and Grade A fabric options, visit <a href="https://egan.com/fabrics-and-textiles/">egan.com/fabrics-and-textiles/</a>	

### 3. FRAME

Code	Description	Price
CA	Clear Anodized	\$ 0
WH	White	\$ 150
BL	Black	\$ 150
CC	Custom Color	\$ 250

### 4. BASE

Code	Description	Price
EM	EganMetallic	\$ 0
WH	White	\$ 150
BL	Black	\$ 150
CC	Custom Color	\$ 250

### EGANINK

Specify EganINK on EVS. Please reach to [our team](#) for an [EganINK](#) quote with your custom art file.

### HOW TO ORDER

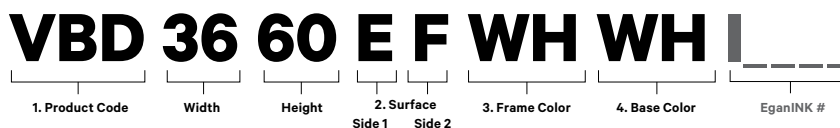

### WHAT'S IN THE BOX

For dry-erase surfaces, two (2) assorted color Dry-Erase Markers, and one (1) EganCloth

# Boxcore Mobile GlassWrite

The Boxcore Mobile utilizes the unique Egan Boxcore™ design for a high degree of stability when moving and when writing. It is distinguished by an ultra-thin bezel, and aluminum frame in 1 1/8" (29mm) depth. The Boxcore Mobile has a frame to base connection, for clean uninterrupted lines. Mobile bases come with easy swivel and locking casters. The Boxcore Mobile GlassWrite is built from a guaranteed-to-clean, crystal clear, low iron tempered safety glass for high clarity of surface. GlassWrite is neo-magent compatible. Select a Pantone color as part of our Egan Infinite Palette program at no additional cost - providing the largest standard glass color offering.

Dimensions	GlassWrite MAG
36"w x 54"h x 23 1/2"d	\$3,700
48"w x 54"h x 23 1/2"d	\$4,590
36"w x 60"h x 23 1/2"d	\$3,890
48"w x 60"h x 23 1/2"d	\$4,820
36"w x 72"h x 23 1/2"d	\$4,560
48"w x 72"h x 23 1/2"d	\$5,470

**GlassWrite MAG cannot be specified with other infills. Use product code VBM to specify two side glass mobile.**

Custom sizes available - Please reach out to sales for a quote.

**1. PRODUCT CODE**

Code	Description
VBM	GlassWrite MAG

**2. GLASS COLOR**

Code	Description	Price
WH	White	\$ 0
IP	Infinite Color Program	\$ 0
CC	Custom Color	\$ 250

Visit [egan.com](http://egan.com) or [pantone.com](http://pantone.com) for colors.

**3. FRAME**

Code	Description	Price
CA	Clear Anodized	\$ 0
WH	White	\$ 150
BL	Black	\$ 150
CC	Custom Color	\$ 250

**4. BASE**

Code	Description	Price
EM	EganMetallic	\$ 0
WH	White	\$ 150
BL	Black	\$ 150
CC	Custom Color	\$ 250

**HOW TO ORDER**

VBM 36 60 WH WH CA EM I \_\_\_\_\_

1. Product Code

Width

Height

2. Glass Color Side 1

2. Glass Color Side 2

4. Frame Color

3. Base Color

EganINk #

**EGANINK** Specify EganINk on Glass. Please reach to [our team](#) for an [EganINk](#) quote with your custom art file.

**WHAT'S IN THE BOX** For dry-erase surfaces, two (2) assorted color Dry-Erase Markers, and one (1) EganCloth

# V-Series Mobile

## Table Shows Pricing Per Side of Board

Dimensions	4 Point Base - VSF				3 Point Base - VST			
	EVS/ per side	Standard Fabric/per side	Grade A Fabric/ per side	Cork/ per side	EVS/ per side	Standard Fabric/ per side	Grade A Fabric/ per side	Cork/ per side
36" w x 54" h x 20" d	\$840	\$940	\$1,080	\$1,080	\$800	\$900	\$1,030	\$1,030
48" w x 54" h x 20" d	\$880	\$980	\$1,120	\$1,120	\$860	\$960	\$1,100	\$1,100
36" w x 60" h x 20" d	\$910	\$1,010	\$1,150	\$1,150	\$820	\$920	\$1,060	\$1,060
48" w x 60" h x 20" d	\$960	\$1,060	\$1,200	\$1,200	\$900	\$1,000	\$1,140	\$1,140
36" w x 72" h x 20" d	\$950	\$1,050	\$1,190	\$1,190	-	-	-	-
48" w x 72" h x 20" d	\$1,010	\$1,110	\$1,250	\$1,250	-	-	-	-

### Projection Compatible

60" w x 72" h x 20" d \$2,750

Table indicates price per side of mobile. ie. Cost of single side EVS is \$840, and 2 sided EVS is \$1,680

V-Series Projection (VPF) - available with EVS on both sides. Upper Panel EVS surface - 58 1/2" w x 47 3/4" h and Lower Panel perforated metal (EM) 58 1/2" w x 12 3/4" h

Custom sizes available - Please reach out to sales for a quote

\*Custom Fabric Upcharge: \$150 List handling fee. Customer required to purchase fabric - COM (customer's own material)

### 1. PRODUCT CODE

Code	Description
VSF	V-Series 4pt
VPF	V-Series 4pt Projection Mobile
VST	V-Series 3pt

### 2. SURFACE

Code	Description
E	EVS
F	Fabric
C	Cork

For a full list of Standard and Grade A fabric options, visit [egan.com/fabrics-and-textiles/](http://egan.com/fabrics-and-textiles/)

### 3. FRAME

Code	Description	Price
CA	Clear Anodized	\$ 0
CC	Custom Color	\$ 250

### 4. BASE

Code	Description	Price
EM	EganMetallic	\$ 0
CC	Custom Color	\$ 250

### EGANINK

Specify EganINK on EVS. Please reach to [our team](#) for an [EganINK](#) quote with your custom art file.

### WHAT'S IN THE BOX

Two (2) assorted color Dry-Erase Markers  
One (1) EganCloth

### ACCESSORIES

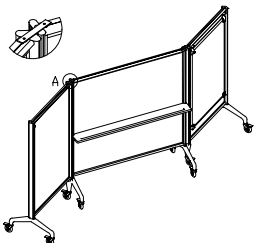

All V-Series Options are finished in EganMetallic (EM).

Code	Description	Price
L	Link Option. Factory installed. Includes one Link Connector and two Vertical Bumpers.	\$100
AVBM27.5	Magnetic Track Kit - 27 1/2" w track for mobiles 30" w or more. 6 lb. capacity.	\$120
AVBM33.5	Magnetic Track Kit - 33 1/2" w track for mobiles 36" w or more. 6 lb. capacity.	\$130
AVBM45.5	Magnetic Track Kit - 45 1/2" w track for mobiles 48" w or more. 6 lb. capacity.	\$140
AVBM57.5	Magnetic Track Kit - 57 1/2" w track for mobiles 60" w or more. 6 lb. capacity.	\$170
ACBUMPER	Upgrade Kit, which includes PVC Protective Bumpers and Link Connectors.	\$130
ACLINK	Additional Single Link Connectors.	\$70
ACSHELF30	Accessory Shelf - 30" w x 1" h x 5" d. Available for VCF, VSF, VGS, VGC, and VGM.	\$210
ACSHELF36	Accessory Shelf - 36" w x 1" h x 5" d. Available for VCF, VSF, VGS, VGC, and VGM.	\$210
ACSHELF48	Accessory Shelf - 48" w x 1" h x 5" d. Available for VCF, VSF, VGS, VGC, and VGM.	\$220
ACSHELF60	Accessory Shelf - 60" w x 1" h x 5" d. Available for VCF, VSF, VGS, VGC, VGM and VPF.	\$220

### HOW TO ORDER

# VST 36 54 E F CA EM L

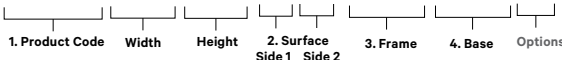

# V-Series Mobile | Split Panel

## Table Shows Pricing Per Side of Board

Dimensions	4 Point Base - VCF					3 Point Base - VCT				
	EVS/ per side	Standard Fabric/ per side	Grade A Fabric/ per side	Cork/ per side	Upgrade Lower Panel/ per side	EVS/ per side	Standard Fabric/ per side	Grade A Fabric/ per side	Cork/ per side	Upgrade Lower Panel/ per side
36" w x 54" h x 20" d	\$860	\$960	\$1,100	\$1,100	\$170	\$830	\$930	\$1,070	\$1,070	\$170
48" w x 54" h x 20" d	\$910	\$1,010	\$1,150	\$1,150	\$170	\$880	\$980	\$1,120	\$1,120	\$170
36" w x 60" h x 20" d	\$930	\$1,030	\$1,170	\$1,170	\$170	\$900	\$1,000	\$1,140	\$1,140	\$170
48" w x 60" h x 20" d	\$990	\$1,090	\$1,230	\$1,230	\$170	\$960	\$1,060	\$1,200	\$1,200	\$170
36" w x 72" h x 20" d	\$980	\$1,080	\$1,220	\$1,220	\$170	-	-	-	-	-
48" w x 72" h x 20" d	\$1,030	\$1,130	\$1,270	\$1,270	\$170	-	-	-	-	-

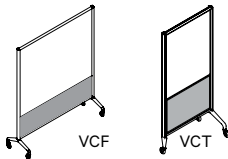

Table indicates price per side of mobile. ie. Cost of single side EVS is \$860, and 2 sided EVS is \$1,720  
 Custom sizes available - Please reach out to sales for a quote.  
 COM (customer's own material) Upcharge: \$150 List handling fee. Customer required to purchase fabric  
 Lower Panel Height: 18 11/16"

Mobiles

### 1. PRODUCT CODE

Code	Description
VCF	V-Series 4pt Split Panel
VCT	V-Series 3pt Split Panel

### 2. SURFACE

Code	Description
E	EVS
F	Fabric
C	Cork

For a full list of Standard and Grade A fabric options, visit [egan.com/fabrics-and-textiles/](http://egan.com/fabrics-and-textiles/)

### 3. FRAME

Code	Description	Price
CA	Clear Anodized	\$ 0
CC	Custom Color	\$ 250

### EGANINK

Specify EganINK on EVS. Please reach to [our team](#) for an [EganINK](#) quote with your custom art file.

### 4. BASE

Code	Description	Price
EM	EganMetallic	\$ 0
CC	Custom Color	\$ 250

### WHAT'S IN THE BOX

Two (2) assorted color Dry-Erase Markers  
 One (1) EganCloth

### ACCESSORIES

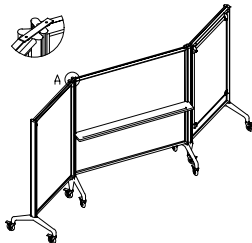

All V-Series accessories are finished in EganMetallic (EM).

Code	Description	Price
L	Link Option. Factory installed. Includes one Link Connector and two Vertical Bumpers.	\$100
AVBM27.5	Magnetic Track Kit - 27 1/2" w track for mobiles 30" w or more. 6 lb. capacity.	\$120
AVBM33.5	Magnetic Track Kit - 33 1/2" w track for mobiles 36" w or more. 6 lb. capacity.	\$130
AVBM45.5	Magnetic Track Kit - 45 1/2" w track for mobiles 48" w or more. 6 lb. capacity.	\$140
AVBM57.5	Magnetic Track Kit - 57 1/2" w track for mobiles 60" w or more. 6 lb. capacity.	\$170
ACBUMPER	Upgrade Kit, which includes PVC Protective Bumpers and Link Connectors.	\$130
ACLINK	Additional Single Link Connectors.	\$70
ACSHELF30	Accessory Shelf - 30" w x 1" h x 5" d. Available for VCF, VSF, VGS, VGC, and VGM.	\$210
ACSHELF36	Accessory Shelf - 36" w x 1" h x 5" d. Available for VCF, VSF, VGS, VGC, and VGM.	\$210
ACSHELF48	Accessory Shelf - 48" w x 1" h x 5" d. Available for VCF, VSF, VGS, VGC, and VGM.	\$220
ACSHELF60	Accessory Shelf - 60" w x 1" h x 5" d. Available for VCF, VSF, VGS, VGC, VGM and VPF.	\$220

### HOW TO ORDER

**VCT 36 54 E F CA EM L**

1. Product Code    Width    Height    2. Surface Side 1 Side 2    3. Frame    4. Base    Options

# V-Series GlassWrite™ Mobile

## Table Shows Pricing Both Sides of Board

Dimensions	SINGLE PANE			SPLIT PANE - GLASSWRITE TOP & TACKABLE BOTTOM		
	Clear	Frosted	GlassWrite MAG	Frosted Standard Fabric	Frosted Grade A Fabric	Frosted Cork
36" w x 54" h x 20" d	\$1 830	\$1 830	\$1 880	\$1 880	\$2 060	\$2 060
48" w x 54" h x 20" d	\$1 950	\$1 950	\$2 010	\$1 990	\$2 170	\$2 170
36" w x 60" h x 20" d	\$1 990	\$1 990	\$2 030	\$2 030	\$2 210	\$2 210
48" w x 60" h x 20" d	\$2 090	\$2 090	\$2 160	\$2 120	\$2 300	\$2 300
36" w x 72" h x 20" d	\$2 200	\$2 200	\$2 280	\$2 240	\$2 420	\$2 420
48" w x 72" h x 20" d	\$2 320	\$2 320	\$2 400	\$2 370	\$2 550	\$2 550

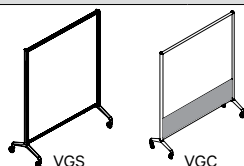

\*Lower Panel Tackable Fabric or Cork - Height: 18 11/16" COM (customer's own material) Upcharge: \$150 List handling fee. Customer required to purchase fabric Custom Color Frame upcharge: \$150/ product Custom sizes available - Please reach out to sales for a quote

### 1. PRODUCT CODE

Code	Description
VGS	V-Series GlassWrite Clear & Frosted
VGM	V-Series GlassWrite MAG
VGC	V-Series GlassWrite Frosted Split Panel
VGM-SS	V-Series GlassWrite MAG Split Panel

### 2. GLASS COLOR

Code	Description	Price
WH	White	\$ 0
IP	Infinite Color Program	\$ 0
CC	Custom Color	\$ 250

Visit [egan.com](http://egan.com) or [pantone.com](http://pantone.com) for colors.

### 3. FRAME

Code	Description	Price
CA	Clear Anodized	\$ 0
CC	Custom Color	\$ 250

### 4. BASE

Code	Description	Price
EM	EganMetallic	\$ 0
CC	Custom Color	\$ 250

### FABRIC

For a full list of Standard and Grade A fabric options, visit [egan.com/fabrics-and-textiles/](http://egan.com/fabrics-and-textiles/)

### EGANINK

Specify EganINK on Glass. Please reach to [our team](#) for an [EganINK](#) quote with your custom art file.

### ACCESSORIES

Code	Description	Price
L	Link Option. Factory installed. Includes one Link Connector and two Vertical Bumpers.	\$100
ACLINK	Additional Single Link Connectors.	\$70
ACSHELF30	Accessory Shelf - 30" w x 1" h x 5" d. Available for VCF, VSF, VGS, VGC, and VGM.	\$210
ACSHELF36	Accessory Shelf - 36" w x 1" h x 5" d. Available for VCF, VSF, VGS, VGC, and VGM.	\$210
ACSHELF48	Accessory Shelf - 48" w x 1" h x 5" d. Available for VCF, VSF, VGS, VGC, and VGM.	\$220
ACSHELF60	Accessory Shelf - 60" w x 1" h x 5" d. Available for VCF, VSF, VGS, VGC, VGM and VPF.	\$220
ACSHELF42	Accessory Shelf - 42" w x 1" h x 5" d. Available for VGS, VGC, and VGM.	\$220

\*All V-Series accessories are finished in EganMetallic (EM).

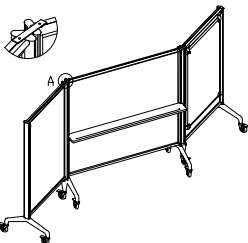

### HOW TO ORDER

**VGC 30 54 CA EM I \_\_\_\_\_**

1. Product Code    2. Width    3. Height    4. Frame    5. Base    6. EganINK File

**VGM 30 54 WH CA EM I \_\_\_\_\_**

1. Product Code    2. Width    3. Height    4. Glass Color    5. Frame    6. Base    7. EganINK File

### WHAT'S IN THE BOX

Two (2) assorted color Dry-Erase Markers  
One (1) EganCloth

# Egan Lite Mobile

Egan Lite Mobiles are incredibly lightweight and easy to move, base options include locking casters or a low profile bases to suit your application. Egan Lite Mobiles can be specified with an EVS or Tackable infill per side.

Pricing reflects costs for 1 side only. Choose an infill for each side and add the price together for the total cost. If the infill is the same for both sides, simply double the cost in the chart below.

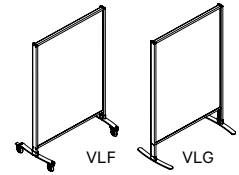

## Table Shows Pricing Per Side of Board

Dimensions	CASTER BASE				GLIDE BASE			
	EVS	Tack Standard Fabric	Tack Grade A Fabric	Tack Cork	EVS	Tack Standard Fabric	Tack Grade A Fabric	Tack Cork
30"w x 54"h x 19"d	\$680	\$750	\$840	\$840	\$650	\$720	\$810	\$810
36"w x 54"h x 19"d	\$720	\$790	\$880	\$880	\$690	\$760	\$850	\$850
42"w x 54"h x 19"d	\$760	\$830	\$920	\$920	\$720	\$790	\$880	\$880
30"w x 60"h x 19"d	\$700	\$770	\$860	\$860	\$670	\$740	\$830	\$830
36"w x 60"h x 19"d	\$730	\$800	\$890	\$890	\$710	\$780	\$870	\$870
42"w x 60"h x 19"d	\$770	\$840	\$930	\$930	\$750	\$820	\$910	\$910
30"w x 66"h x 19"d	\$710	\$780	\$870	\$870	\$680	\$750	\$840	\$840
36"w x 66"h x 19"d	\$750	\$820	\$910	\$910	\$720	\$790	\$880	\$880
42"w x 66"h x 19"d	\$790	\$860	\$950	\$950	\$760	\$830	\$920	\$920
60"w x 66" h x 19"d*	\$950	-	-	-	-	-	-	-

Custom sizes available - Please reach out to sales for a quote.  
 COM (customer's own material) Upcharge: \$150 List handling fee. Customer required to purchase fabric  
 \*Egan LiteProjection (VLF) - available with EVS on both sides.

### 1. PRODUCT CODE

Code	Description
VLF	Egan Lite Caster Base
VLG	Egan Lite Glide Base

### 2. SURFACE

Code	Description
E	EVS
F	Fabric

For a full list of Standard and Grade A fabric options, visit [egan.com/fabrics-and-textiles/](http://egan.com/fabrics-and-textiles/)

### 3. FRAME

Code	Description	Price
CA	Clear Anodized	\$ 0
CC	Custom Color	\$ 250

### 4. BASE

Code	Description	Price
EM	EganMetallic	\$ 0
CC	Custom Color	\$ 250

### FABRIC

For a full list of Standard and Grade A fabric options, visit [egan.com/fabrics-and-textiles/](http://egan.com/fabrics-and-textiles/)

### EGANINK

Specify EganINK on Glass. Please reach to [our team](#) for an [EganINK](#) quote with your custom art file.

### HOW TO ORDER



# Egan Lite Screen Door Mobile

Egan Lite Screen Door features a weighted trip-free base with exceptional stability and rotation through 360°. A 90° notch in the base provides compatibility with any wall or partition system. The no-lock front caster rolls smoothly and ensures door will fold back to permit free traffic flow.

Egan Lite Screen Doors can be specified with an EVS or Tackable infill per side. Pricing reflects costs for 1 side only. Choose an infill for each side and add the price together for the total cost. If the infill is the same for both sides, simply double the cost in the chart below.

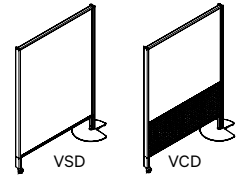

## Table Shows Pricing Per Side of Board

Dimensions	SINGLE PANEL				SPLIT PANEL - TOP: EVS or TACK   BOTTOM: PERFORATED PANEL			
	EVS	Tack Standard Fabric	Tack Grade A Fabric	Tack Cork	EVS	Tack Standard Fabric	Tack Grade A Fabric	Tack Cork
36" w x 54" h x 15" d	\$860	\$950	\$1 040	\$1 040	\$890	\$980	\$1 070	\$1 070
48" w x 54" h x 19" d	\$910	\$1 000	\$1 090	\$1 090	\$930	\$1 020	\$1 110	\$1 110
36" w x 60" h x 19" d	\$880	\$970	\$1 060	\$1 060	\$900	\$990	\$1 080	\$1 080
48" w x 60" h x 19" d	\$920	\$1 010	\$1 100	\$1 100	\$980	\$1 070	\$1 130	\$1 130

Custom sizes available - Please reach out to sales for a quote.

Lower Panel is perforated metal/ punched steel with 3/16" hole x 5/16" stagger

Custom Fabric Upcharge: \$150 List handling fee. Customer required to purchase fabric - COM (customer's own material).

### 1. PRODUCT CODE

Code	Description
VSD	Egan Lite Screen Door
VCD	Egan Lite Screen Door - Split

### 2. SURFACE

Code	Description
E	EVS
F	Fabric

For a full list of Standard and Grade A fabric options, visit [egan.com/fabrics-and-textiles/](http://egan.com/fabrics-and-textiles/)

### 3. FRAME

Code	Description	Price
CA	Clear Anodized	\$ 0
CC	Custom Color	\$ 250

### 4. BASE

Code	Description	Price
EM	EganMetallic	\$ 0
CC	Custom Color	\$ 250

### FABRIC

For a full list of Standard and Grade A fabric options, visit [egan.com/fabrics-and-textiles/](http://egan.com/fabrics-and-textiles/)

### EGANINK

Specify EganINK on Glass. Please reach to [our team](#) for an [EganINK](#) quote with your custom art file.

### HOW TO ORDER

**VSD 30 74 E F CA EM 463490-001 I**

1. Product Code   
 Width   
 Height   
 2. Surface Side 1 Side 2   
 3. Frame   
 4. Base   
 Maharam Fabric Pattern and Description   
 EganINK File



# A-Frame VersaMobile

A-Frame VersaMobiles offer two-sided high-performance EVS™ dry-erase surface. Specify any combination of EVS™ magnetic surface or Egan tackable fabric. A fixed track at the top of the A-Frame accommodates lightweight VersaBoards or EganSystem Track boards. Perfect for mobile presentations. Additional VersaBoards or 202 EganSystem Boards sold separately. Storage for up to five boards is available inside the spacious A-Frame shelf cavity. Ships with Clear Anodized (CA) aluminum finish. Base options include locking casters.



A-Frame Mobiles can be specified with a different infill per side. Pricing reflects costs for 1 side only. Choose an infill for each side and add the price together for the total cost. If the infill is the same for both sides, simply double the cost in the chart below.

## Table Shows Pricing Per Side of Board

Dimensions	Description	EVS/ per side	Tack Standard Fabric/ per side	Tack Grade A Fabric/ per side	Tack Cork/ per side
30" w x 74" h x 21" d	Stores up to five 26" x 36" VersaBoards, sold separately. EganSystem Boards are too large for this model.	\$1,240	\$1,380	\$1,520	\$1,520
36" w x 74" h x 21" d	Stores up to five 26" x 36" or 36" x 48" VersaBoards or up to five 36" x 48" 202 EganSystem markerboards, sold separately.	\$1,320	\$1,460	\$1,600	\$1,600
42" w x 74" h x 21" d	Stores up to five 26" x 36" or 36" x 48" VersaBoards or up to five 36" x 48" 202 EganSystem markerboards, sold separately.	\$1,380	\$1,520	\$1,660	\$1,660
48" w x 74" h x 21" d	Stores up to five 26" x 36" or 36" x 48" VersaBoards or up to five 36" x 48" 202 EganSystem markerboards, sold separately.	\$1,450	\$1,590	\$1,730	\$1,730

COM (customer's own material) Upcharge: \$150 List handling fee. Customer required to purchase fabric

### 1. PRODUCT CODE

Code	Description
KEA	A-Frame Mobile

### 2. SURFACE

Code	Description
E	EVS
F	Fabric
For a full list of Standard and Grade A fabric options, visit <a href="https://egan.com/fabrics-and-textiles/">egan.com/fabrics-and-textiles/</a>	

### EGANINK

Specify EganINK on EVS. Please reach to [our team](#) for an [EganINK](#) quote with your custom art file.

### HOW TO ORDER

**KEA 30 74 E F 463490-001 I**

1. Product Code      Width      Height      2. Surface Side 1 Side 2      Maharam Fabric Pattern and Description      EganINK File

### WHAT'S IN THE BOX

For dry-erase surfaces, two (2) assorted color Dry-Erase Markers, and one (1) EganCloth

## Egan TableScreens

### ■ Architrave

---

Architrave products are defined by their sturdy, wood oak Boxcore 1 1/8" (29mm) frame. Features of the Architrave family consist of thin bezel edge of 1/4" (6mm), a robust construction with a clean external appearance and no extraneous materials. Specify your Architrave TableScreen from a range of infill options, such as EVS, GlassWrite, Tackable fabric.

### ■ Boxcore 29

---

The rectilinear minimalist design of the Boxcore 29 presentation board is available as a versatile, demountable office enhancement in the form of the Boxcore 29 TableScreen™. Available in a range of infill options, such as EVS, GlassWrite and Tackable fabrics. Specify EganINK on any material to enhance productivity and design.

### ■ Dimension

---

The design principles of the Dimension family extend into the Dimension TableScreen, with its crisp, clean lines that promote a minimalist esthetic and create consistency and uniformity when specified with the Dimension line of Marker and Tackboards.

### ■ GlassWrite

---

The GlassWrite TableScreen is an elegant, framless 1/2" (13mm) thick singular piece of glass with polished and chamfered edges. Available in Frosted or Clear glass with the option to illuminate the GlassWrite panel with a LED light embedded into the base.

### ■ V-Series

---

Formerly M-Series, the V-Series TableScreen is part of the V-Series design family which has a sturdy aluminum frame and a range of infill options, such as: EVS, Frosted Glass, Cork and Tackable Fabric. The V-Series TableScreen also has a unique mount (as shown on page 53), making it extremely easy to install.

### ■ Fabric

---

Create functional privacy without compromising design elements in open concept environments. Available with 5 Standard Fabric patterns with a wide selection of colorways for each pattern or upgrade to Grade A Maharam fabrics. COM available contact Egan Rep or Egan Customer Service for details.

# Egan TableScreens™ Mount Options

Surface Mount, Joiner Clamp, Cross Clamp and Edge Clamp are available on all Egan TableScreens™. Mount options shown below apply to Dimension, GlassWrite™, Architrave and Boxcore™ models. Dimension TableScreen shown below.

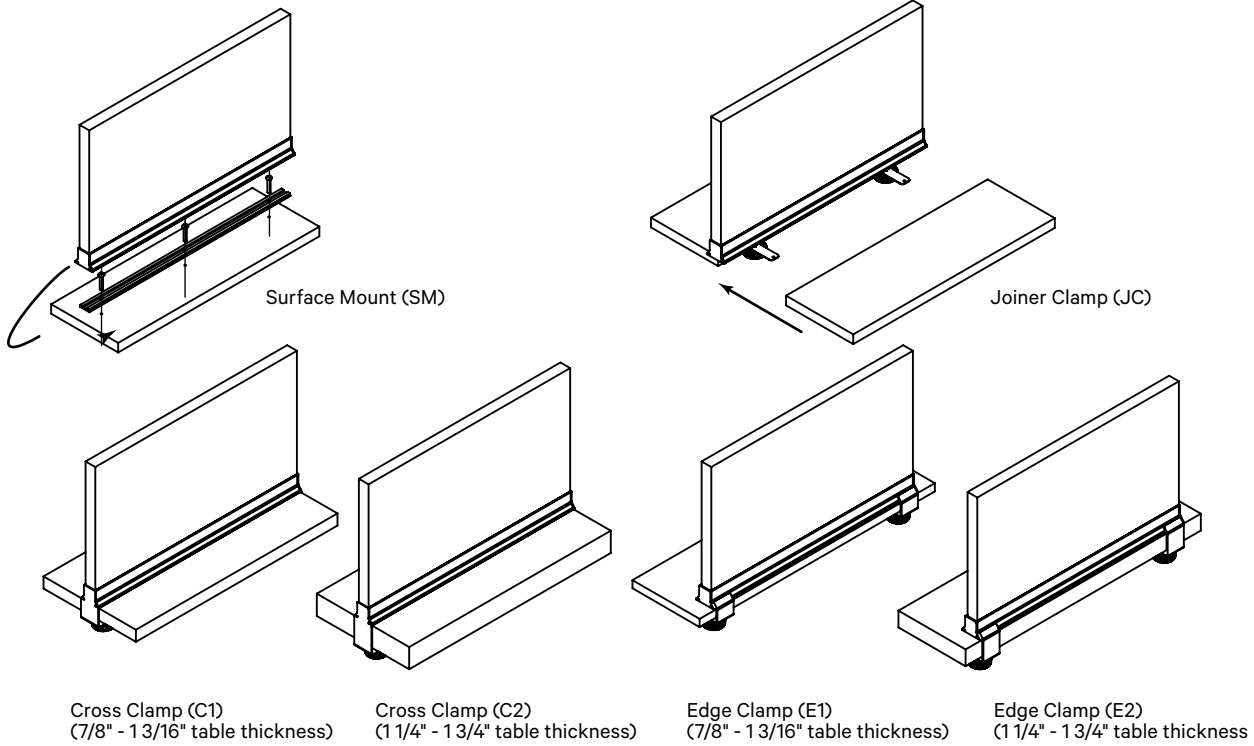

Surface Mount, Joiner Clamp, Cross Clamp and Edge Clamp are available on all Egan TableScreens™. Mount options shown below apply to V-Series TableScreens.

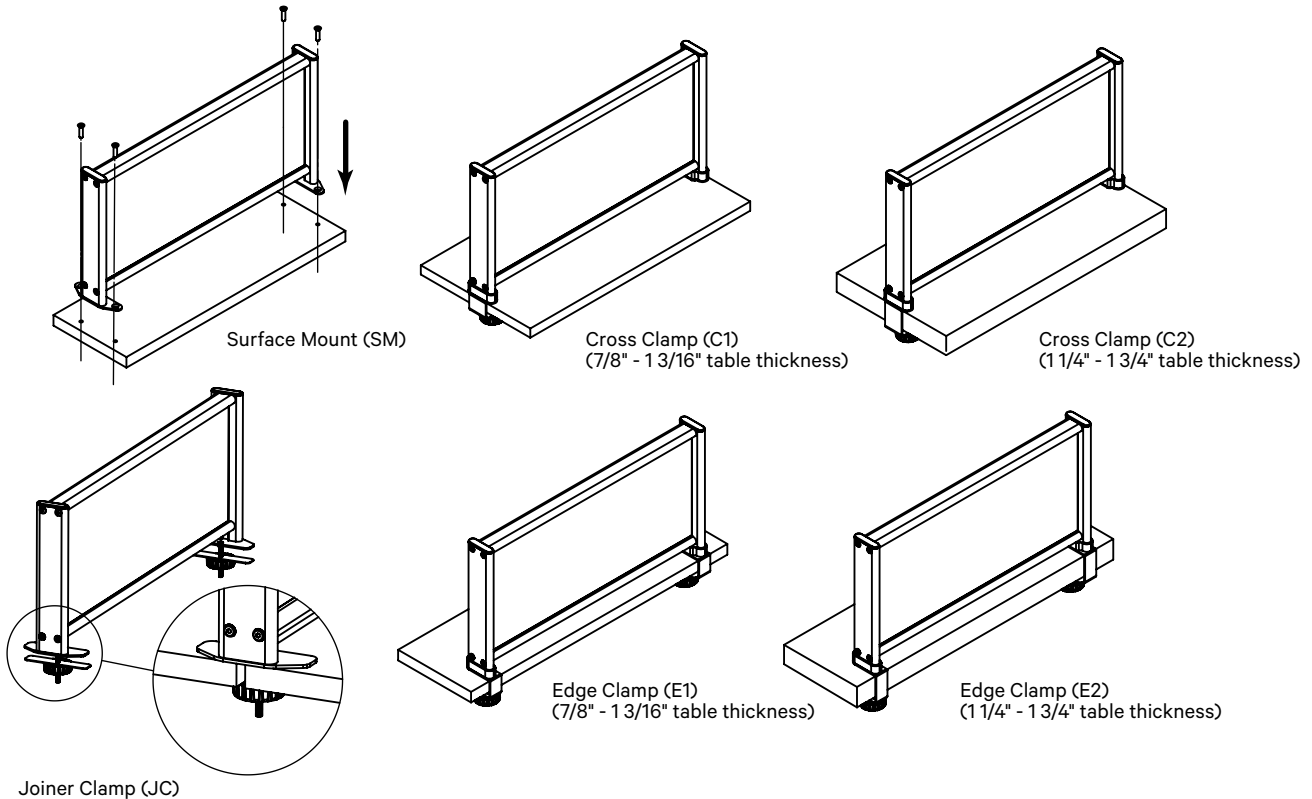

Parcel Service items (📦) ship 'Freight Included'.

# Architrave TableScreen

TableScreens can be specified with a different infill per side. Pricing reflects costs for 1 side only. Choose an infill for each side and add the price together for the total cost. If the infill is the same for both sides, simply double the cost in the chart below.

## Table Shows Pricing Per Side of Board

Dimension	EVS/ per side	Tack EcoTack/ per side	Tack Standard Fabric/ per side	Tack Grade A Fabric / per side
24" w x 12" h	\$320	\$330	\$350	\$400
24" w x 14" h	\$330	\$340	\$360	\$410
24" w x 18" h	\$335	\$350	\$370	\$420
24" w x 24" h	\$340	\$360	\$380	\$440
30" w x 12" h	\$335	\$350	\$370	\$440
30" w x 14" h	\$340	\$360	\$380	\$450
30" w x 18" h	\$360	\$370	\$390	\$470
30" w x 24" h	\$370	\$390	\$410	\$490
36" w x 12" h	\$350	\$360	\$380	\$450
36" w x 14" h	\$370	\$380	\$410	\$480
36" w x 18" h	\$390	\$410	\$430	\$510
36" w x 24" h	\$420	\$450	\$460	\$550
48" w x 12" h	\$360	\$380	\$400	\$460
48" w x 14" h	\$390	\$410	\$430	\$500
48" w x 18" h	\$420	\$440	\$460	\$540
48" w x 24" h	\$460	\$480	\$510	\$590
60" w x 12" h	\$390	\$410	\$430	\$520
60" w x 14" h	\$410	\$430	\$450	\$550
60" w x 18" h	\$450	\$480	\$500	\$600
60" w x 24" h	\$510	\$530	\$560	\$670
72" w x 12" h	\$410	\$430	\$450	\$570
72" w x 14" h	\$450	\$470	\$490	\$600
72" w x 18" h	\$490	\$510	\$530	\$650
72" w x 24" h	\$550	\$560	\$600	\$720

Custom sizes available - Use price from the next larger size. For example, 20" w x 12" h use pricing from the next larger size (24" w x 12" h)

COM (customer's own material) Upcharge: \$150 List handling fee. Customer required to purchase fabric

### 2. MOUNT

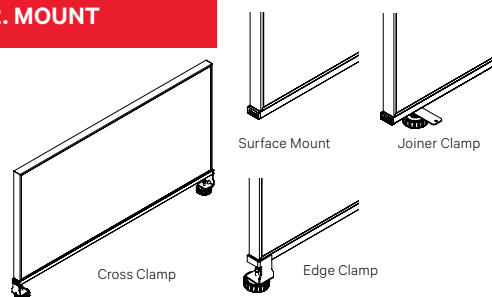

Code	Description
<b>E1</b>	Install TableScreen along the edge of a 7/8" to 1 3/16" thick table using an Edge Clamp.
<b>E2</b>	Install TableScreen along the edge of a 1 1/4" to 1 3/4" thick table using an Edge Clamp.
<b>C1</b>	Install TableScreen across a surface of a 7/8" to 1 3/16" thick table using a Cross Clamp.
<b>C2</b>	Install TableScreen across a surface of a 1 1/4" to 1 3/4" thick table using a Cross Clamp.
<b>SM</b>	Install TableScreen across a surface or along the edge of a table using a Surface Mount.
<b>JC</b>	Install TableScreen along the seams of two adjacent tables using a Joiner Clamp.

### HOW TO ORDER

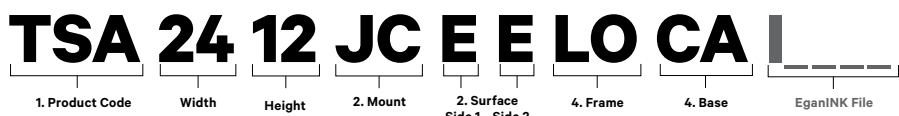

### WHAT'S IN THE BOX

For dry-erase surfaces, two (2) assorted color Dry-Erase Markers, and one (1) EganCloth

### 1. PRODUCT CODE

Code	Description
<b>TSA</b>	EVS   Framed

### 3. SURFACE

Code	Description
<b>E</b>	EVS
<b>T</b>	EcoTack/PET
<b>F</b>	Fabric

For a full list of Standard and Grade A fabric options, visit [egan.com/fabrics-and-textiles/](http://egan.com/fabrics-and-textiles/)

### 4. FRAME STAINS

Code	Description
<b>LO</b>	Light Oak
<b>MO</b>	Medium Oak
<b>DO</b>	Dark Oak
<b>BO</b>	Black Oak
<b>CS</b>	Custom Stain - \$ 300

### EGANINK

Specify EganINK on EVS. Please reach to [our team](#) for an [EganINK](#) quote with your custom art file.

# Architrave TableScreen GlassWrite

Distinguished by a sturdy 1 1/8" wood oak frame, Architrave TableScreen is available in four distinct stains and comes with various infill options. GlassWrite is built from a guaranteed-to-clean, crystal clear, low iron tempered safety glass for high clarity of surface. GlassWrite is neo-magent compatible and is available with Egan Infinite Palette - choose from 1,050 standard glass colors.

Dimension	GlassWrite MAG
24"w x 12"h	\$960
24"w x 14"h	\$1,060
24"w x 18"h	\$1,260
24"w x 24"h	\$1,670
30"w x 12"h	\$1,120
30"w x 14"h	\$1,270
30"w x 18"h	\$1,520
30"w x 24"h	\$1,930
36"w x 12"h	\$1,270
36"w x 14"h	\$1,480
36"w x 18"h	\$1,790
36"w x 24"h	\$2,250
48"w x 12"h	\$1,650
48"w x 14"h	\$1,860
48"w x 18"h	\$2,270
48"w x 24"h	\$3,030
60"w x 12"h	\$2,010
60"w x 14"h	\$2,320
60"w x 18"h	\$2,810
60"w x 24"h	\$3,370
72"w x 12"h	\$2,340
72"w x 14"h	\$2,760
72"w x 18"h	\$3,370
72"w x 24"h	\$4,860

**GlassWrite MAG cannot be specified with other infills.**  
 Custom sizes available - Please reach out to sales for a quote.

## 1. PRODUCT CODE

Code	Description
TSA	GlassWrite

## 3. SURFACE

Code	Description
GG	GlassWriteMAG

## 4. GLASS COLOR

Code	Description	Price
WH	White	\$ 0
IP	Infinite Color Program	\$ 0
CC	Custom Color	\$ 250

Visit [egan.com](http://egan.com) or [pantone.com](http://pantone.com) for colors.

## 5. FRAME STAINS

Code	Description
LO	Light Oak
MO	Medium Oak
DO	Dark Oak
BO	Black Oak
CS	Custom Stain - \$ 300

## EGANINK

Specify EganINK on Glass. Please reach to [our team](#) for an [EganINK](#) quote with your custom art file.

## 2. MOUNT

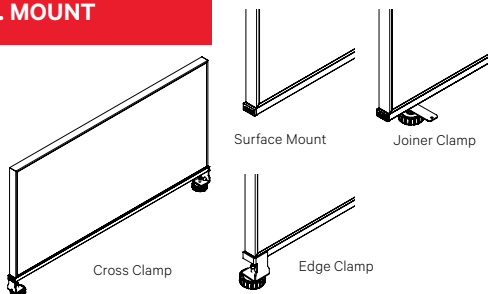

Code	Description
E1	Install TableScreen along the edge of a 7/8" to 1 3/16" thick table using an Edge Clamp.
E2	Install TableScreen along the edge of a 1 1/4" to 1 3/4" thick table using an Edge Clamp.
C1	Install TableScreen across a surface of a 7/8" to 1 3/16" thick table using a Cross Clamp.
C2	Install TableScreen across a surface of a 1 1/4" to 1 3/4" thick table using a Cross Clamp.
SM	Install TableScreen across a surface or along the edge of a table using a Surface Mount.
JC	Install TableScreen along the seams of two adjacent tables using a Joiner Clamp.

## HOW TO ORDER

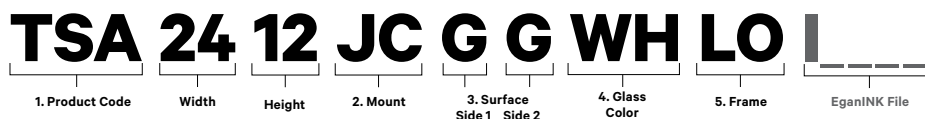

## WHAT'S IN THE BOX

For dry-erase surfaces, two (2) assorted color Dry-Erase Markers, and one (1) EganCloth

# Boxcore™ 29 TableScreens™

TableScreens can be specified with a different infill per side. Pricing reflects costs for 1 side only. Choose an infill for each side and add the price together for the total cost. If the infill is the same for both sides, simply double the cost in the chart below.

## Table Shows Pricing Per Side of Board

Dimension	EVS /per side	Tack EcoTack /per side	Tack Standard Fabric/per side	Tack Grade A Fabric / per side
24"w x 12"h	\$320	\$330	\$350	\$400
24"w x 14"h	\$330	\$340	\$360	\$410
24"w x 18"h	\$330	\$350	\$370	\$420
24"w x 24"h	\$340	\$360	\$380	\$440
30"w x 12"h	\$340	\$360	\$370	\$440
30"w x 14"h	\$340	\$360	\$380	\$450
30"w x 18"h	\$360	\$370	\$390	\$470
30"w x 24"h	\$370	\$390	\$410	\$490
36"w x 12"h	\$350	\$360	\$380	\$450
36"w x 14"h	\$370	\$380	\$410	\$480
36"w x 18"h	\$390	\$410	\$430	\$510
36"w x 24"h	\$420	\$450	\$460	\$550
48"w x 12"h	\$360	\$380	\$400	\$460
48"w x 14"h	\$390	\$410	\$430	\$500
48"w x 18"h	\$420	\$440	\$460	\$540
48"w x 24"h	\$460	\$480	\$510	\$590
60"w x 12"h	\$390	\$410	\$430	\$520
60"w x 14"h	\$410	\$430	\$450	\$550
60"w x 18"h	\$450	\$480	\$500	\$600
60"w x 24"h	\$510	\$530	\$560	\$670
72"w x 12"h	\$410	\$430	\$450	\$570
72"w x 14"h	\$450	\$470	\$490	\$600
72"w x 18"h	\$490	\$510	\$530	\$650
72"w x 24"h	\$550	\$520	\$600	\$720

Custom sizes available - Use price from the next larger size. For example, 20" w x 12" h use pricing from the next larger size (24" w x 12" h)

Custom Fabric Upcharge: \$150 List handling fee. Customer required to purchase fabric COM (customer's own material).

### 1. PRODUCT CODE

Code	Description
TSB	EVS, Fabric, or EcoTack

### 3. SURFACE

Code	Description
E	EVS
T	EcoTack/PET (EganMetallic color)
F	Fabric
For a full list of Standard and Grade A fabric options, visit <a href="http://egan.com/fabrics-and-textiles/">egan.com/fabrics-and-textiles/</a>	

### 4. FRAME & BASE

Code	Description	Price
CA	Clear Anodized	\$ 0
WH	White	\$ 150
BL	Black	\$ 150
CC	Custom Color	\$ 250

### EGANINK

Specify EganINK on Glass. Please reach to [our team](#) for an [EganINK](#) quote with your custom art file.

### 2. MOUNT

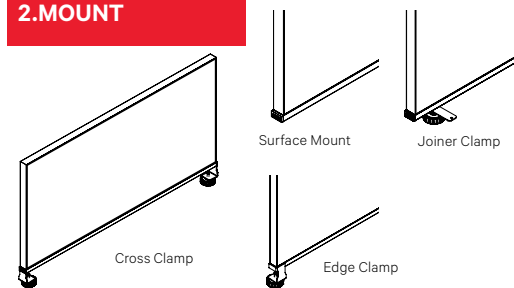

Code	Description
E1	Install TableScreen along the edge of a 7/8" to 1 3/16" thick table using an Edge Clamp.
E2	Install TableScreen along the edge of a 1 1/4" to 1 3/4" thick table using an Edge Clamp.
C1	Install TableScreen across a surface of a 7/8" to 1 3/16" thick table using a Cross Clamp.
C2	Install TableScreen across a surface of a 1 1/4" to 1 3/4" thick table using a Cross Clamp.
SM	Install TableScreen across a surface or along the edge of a table using a Surface Mount.
JC	Install TableScreen along the seams of two adjacent tables using a Joiner Clamp.

### HOW TO ORDER

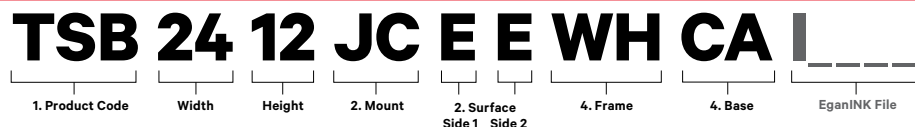

### WHAT'S IN THE BOX

For dry-erase surfaces, two (2) assorted color Dry-Erase Markers, and one (1) EganCloth

# Boxcore™ 29 TableScreens™ GlassWrite

Distinguished by an ultra-thin bezel, and a clear anodized aluminum frame in 1 1/8" (29mm) depth. The Boxcore TableScreen GlassWrite is built from a guaranteed-to-clean, crystal clear, low iron tempered safety glass for high clarity of surface. GlassWrite is neo-magent compatible and is available with Egan Infinite Palette - choose from 1,050 standard glass colors.

Dimension	GlassWriteMAG
24"w x 12"h	\$960
24"w x 14"h	\$1,060
24"w x 18"h	\$1,260
24"w x 24"h	\$1,670
30"w x 12"h	\$1,120
30"w x 14"h	\$1,270
30"w x 18"h	\$1,520
30"w x 24"h	\$1,930
36"w x 12"h	\$1,270
36"w x 14"h	\$1,480
36"w x 18"h	\$1,790
36"w x 24"h	\$2,250
48"w x 12"h	\$1,650
48"w x 14"h	\$1,860
48"w x 18"h	\$2,270
48"w x 24"h	\$3,030
60"w x 12"h	\$2,010
60"w x 14"h	\$2,320
60"w x 18"h	\$2,810
60"w x 24"h	\$3,370
72"w x 12"h	\$2,340
72"w x 14"h	\$2,760
72"w x 18"h	\$3,370
72"w x 24"h	\$4,860

Custom sizes available - Please reach out to sales for a quote.

**1. PRODUCT CODE**

Code	Description
TSGB	GlassWriteMAG

**3. GLASS COLOR**

Code	Description	Price
WH	White	\$ 0
IP	Infinite Color Program	\$ 0
CC	Custom Color	\$ 250

Visit [egan.com](http://egan.com) or [pantone.com](http://pantone.com) for colors.

**4. FRAME & BASE**

Code	Description	Price
CA	Clear Anodized	\$ 0
WH	White	\$ 150
BL	Black	\$ 150
CC	Custom Color	\$ 250

**EGANINK** Specify EganINK on Glass. Please reach to [our team](#) for an [EganINK](#) quote with your custom art file.

TableScreens

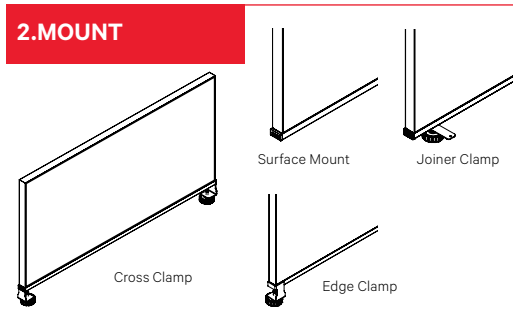

Code	Description
E1	Install TableScreen along the edge of a 7/8" to 1 3/16" thick table using an Edge Clamp.
E2	Install TableScreen along the edge of a 1 1/4" to 1 3/4" thick table using an Edge Clamp.
C1	Install TableScreen across a surface of a 7/8" to 1 3/16" thick table using a Cross Clamp.
C2	Install TableScreen across a surface of a 1 1/4" to 1 3/4" thick table using a Cross Clamp.
SM	Install TableScreen across a surface or along the edge of a table using a Surface Mount.
JC	Install TableScreen along the seams of two adjacent tables using a Joiner Clamp.

**HOW TO ORDER**

**TSGB 24 12 JC WH WH CA I**

1. Product Code    Width    Height    2. Mount    3. Glass Color Side 1 Side 2    4. Frame & Base    EganINK File

**WHAT'S IN THE BOX** For dry-erase surfaces, two (2) assorted color Dry-Erase Markers, and one (1) EganCloth

# GlassWrite TableScreens™

TableScreens can be specified with one infill material only. Pricing reflects costs for both sides.

Dimension	GlassWrite   Clear	GlassWrite   Frosted	GlassWrite   Lumens
24" w x 12" h	\$610	\$610	\$820
24" w x 14" h	\$650	\$650	\$860
30" w x 12" h	\$690	\$690	\$920
30" w x 14" h	\$750	\$750	\$980
36" w x 12" h	\$960	\$960	\$1,220
36" w x 14" h	\$1,020	\$1,020	\$1,260
48" w x 12" h	\$1,240	\$1,240	\$1,530
48" w x 14" h	\$1,290	\$1,290	\$1,600
60" w x 12" h	\$1,370	\$1,370	\$1,740
60" w x 14" h	\$1,450	\$1,450	\$1,820
72" w x 12" h	\$1,520	\$1,520	\$1,910
72" w x 14" h	\$1,600	\$1,600	\$2,010

## 1. PRODUCT CODE

Code	Description
TSG	GlassWrite   Frameless



Custom sizes available - Use price from the next larger size. For example, 20" w x 12" h use pricing from the next larger size (24" w x 12" h)  
 Custom Fabric Upcharge: \$150 List handling fee. Customer required to purchase fabric COM (customer's own material).

## 2. MOUNT

Code	Description
E1	Install TableScreen along the edge of a 7/8" to 1 3/16" thick table using an Edge Clamp.
E2	Install TableScreen along the edge of a 1 1/4" to 1 3/4" thick table using an Edge Clamp.
C1	Install TableScreen across a surface of a 7/8" to 1 3/16" thick table using a Cross Clamp.
C2	Install TableScreen across a surface of a 1 1/4" to 1 3/4" thick table using a Cross Clamp.
SM	Install TableScreen across a surface or along the edge of a table using a Surface Mount.
JC	Install TableScreen along the seams of two adjacent tables using a Joiner Clamp.

## 3. SURFACE

Code	Description
GC	Clear
GF	Frosted

## 4. OPTION

Code	Description
L	Lumens

## HOW TO ORDER



## WHAT'S IN THE BOX

Two (2) assorted color Dry-Erase Markers  
 One (1) EganCloth



# Dimension Stele™ TableScreens™

TableScreens can be specified with a different infill per side. Pricing reflects costs for 1 side only. Choose an infill for each side and add the price together for the total cost. If the infill is the same for both sides, simply double the cost in the chart below.

## Table Shows Pricing Per Side of Board

Dimension	EVS/per side	Tack EcoTack/per side	Tack Standard Fabric/per side	Tack Grade A Fabric/per side
24"w x 12"h	\$270	\$280	\$290	\$320
24"w x 14"h	\$290	\$300	\$300	\$330
24"w x 18"h	\$290	\$310	\$310	\$360
30"w x 12"h	\$300	\$310	\$320	\$350
30"w x 14"h	\$310	\$320	\$330	\$360
30"w x 18"h	\$330	\$340	\$350	\$420
36"w x 12"h	\$320	\$330	\$340	\$370
36"w x 14"h	\$340	\$350	\$360	\$400
36"w x 18"h	\$360	\$370	\$380	\$420
48"w x 12"h	\$340	\$340	\$360	\$470
48"w x 14"h	\$360	\$370	\$380	\$420
48"w x 18"h	\$410	\$420	\$430	\$470
60"w x 12"h	\$360	\$370	\$380	\$420
60"w x 14"h	\$400	\$410	\$420	\$470
60"w x 18"h	\$440	\$450	\$460	\$510
72"w x 12"h	\$400	\$410	\$420	\$470
72"w x 14"h	\$450	\$460	\$470	\$520
72"w x 18"h	\$470	\$480	\$500	\$560

Custom sizes available - Use price from the next larger size. For example, 20"w x 12"h use pricing from the next larger size (24"w x 12"h)

Custom Fabric Upcharge: \$150 List handling fee. Customer required to purchase fabric COM (customer's own material).

### 1. PRODUCT CODE

Code	Description
TSDM	Dimension   Frameless

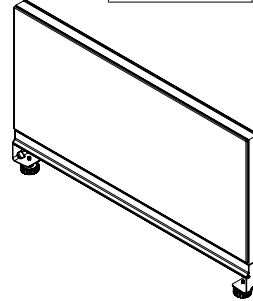

### 2. MOUNT

Code	Description
E1	Install TableScreen along the edge of a 7/8" to 1 3/16" thick table using an Edge Clamp.
E2	Install TableScreen along the edge of a 1 1/4" to 1 3/4" thick table using an Edge Clamp.
C1	Install TableScreen across a surface of a 7/8" to 1 3/16" thick table using a Cross Clamp.
C2	Install TableScreen across a surface of a 1 1/4" to 1 3/4" thick table using a Cross Clamp.
SM	Install TableScreen across a surface or along the edge of a table using a Surface Mount.
JC	Install TableScreen along the seams of two adjacent tables using a Joiner Clamp.

### 3. EDGE COLOR

Code	Description	Price
WH	White	\$ 0
CC	Custom Color	\$ 250

### 4. SURFACE

Code	Description
E	EVS
T	EcoTack/PET (EganMetallic color)
F	Fabric

For a full list of Standard and Grade A fabric options, visit [egan.com/fabrics-and-textiles/](https://egan.com/fabrics-and-textiles/)

### EGANINK

Specify EganINK on EVS. Please reach to [our team](#) for an [EganINK](#) quote with your custom art file.

### HOW TO ORDER

<b>TSDM</b>	<b>24</b>	<b>18</b>	<b>E1</b>	<b>WH</b>	<b>E</b>	<b>F</b>
1. Product Code	Width	Height	2. Mount	3. Edge Color	4. Surface Side 1	Side 2

### WHAT'S IN THE BOX

Two (2) assorted color Dry-Erase Markers  
One (1) EganCloth

# V-Series TableScreens™

TableScreens can be specified with a different infill per side. Pricing reflects costs for 1 side only. Choose an infill for each side and add the price together for the total cost. If the infill is the same for both sides, simply double the cost in the chart below.

## Table Shows Pricing Per Side of Board

Dimension	EVS/ per side	GlassWrite Frosted/ per side	Tack EcoTack/ per side	Tack Standard Fabric /per side	Tack Grade A Fab- ric/per side	Tack Cork/per side
24" w x 12" h	\$360	\$390	\$380	\$400	\$490	\$490
24" w x 14" h	\$370	\$400	\$390	\$410	\$500	\$500
24" w x 18" h	\$380	\$410	\$400	\$420	\$510	\$510
30" w x 12" h	\$380	\$410	\$400	\$420	\$520	\$520
30" w x 14" h	\$390	\$420	\$410	\$430	\$550	\$550
30" w x 18" h	\$400	\$430	\$420	\$440	\$560	\$560
36" w x 12" h	\$390	\$420	\$410	\$430	\$540	\$540
36" w x 14" h	\$410	\$440	\$430	\$450	\$570	\$570
36" w x 18" h	\$430	\$460	\$450	\$470	\$600	\$600
48" w x 12" h	\$400	\$430	\$420	\$440	\$550	\$550
48" w x 14" h	\$430	\$460	\$450	\$470	\$590	\$590
48" w x 18" h	\$460	\$490	\$480	\$510	\$640	\$640
60" w x 12" h	\$420	\$450	\$450	\$460	\$610	\$610
60" w x 14" h	\$460	\$490	\$480	\$510	\$650	\$650
60" w x 18" h	\$490	\$520	\$510	\$530	\$680	\$680
72" w x 12" h	\$440	\$470	\$460	\$490	\$640	\$640
72" w x 14" h	\$480	\$510	\$510	\$530	\$690	\$690
72" w x 18" h	\$520	\$550	\$550	\$570	\$740	\$740

### 1. PRODUCT CODE

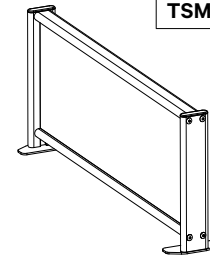

Code	Description
TSM	V-Series   Framed

### 2. MOUNT

Code	Description
E1	Install TableScreen along the edge of a 7/8" to 1 3/16" thick table using an Edge Clamp.
E2	Install TableScreen along the edge of a 1 1/4" to 1 3/4" thick table using an Edge Clamp.
C1	Install TableScreen across a surface of a 7/8" to 1 3/16" thick table using a Cross Clamp.
C2	Install TableScreen across a surface of a 1 1/4" to 1 3/4" thick table using a Cross Clamp.
SM	Install TableScreen across a surface or along the edge of a table using a Surface Mount.
JC	Install TableScreen along the seams of two adjacent tables using a Joiner Clamp.

Custom sizes available - Use price from the next larger size. For example, 20" w x 12" h use pricing from the next larger size (24" w x 12" h).

Custom Fabric Upcharge: \$150 List handling fee. Customer required to purchase fabric COM (customer's own material).

Custom Color Frame upcharge: \$250/ product.

### 3. SURFACE

Code	Description
E	EVS
GG	Frosted Glass (Glass must be specified both sides.)
C	Natural Cork
T	EcoTack/PET (Egan Metallic color)
F	Fabric

For a full list of Standard and Grade A fabric options, visit [egan.com/fabrics-and-textiles/](http://egan.com/fabrics-and-textiles/)

### 4. FRAME

Code	Description	Price
CA	Clear Anodized	\$ 0
CC	Custom Color	\$ 250

### EGANINK

Specify EganINK on EVS. Please reach to [our team](#) for an [EganINK](#) quote with your custom art file.

### HOW TO ORDER

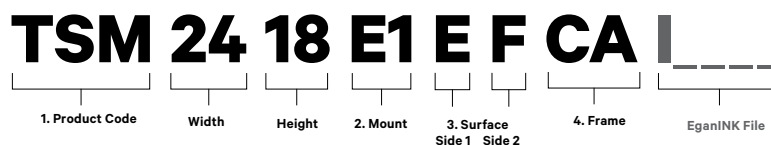

### WHAT'S IN THE BOX

For dry-erase surfaces, two (2) assorted color Dry-Erase Markers, and one (1) EganCloth

# FabricTableScreens™

TableScreens can be specified with a one infill/ material only. Pricing reflects costs for both sides.

Dimension	Tack   Standard Fabric	Tack   Grade A Fabric
24" w x 12" h	\$730	\$790
24" w x 14" h	\$760	\$830
24" w x 18" h	\$790	\$870
30" w x 12" h	\$760	\$860
30" w x 14" h	\$790	\$900
30" w x 18" h	\$830	\$940
36" w x 12" h	\$790	\$890
36" w x 14" h	\$820	\$920
36" w x 18" h	\$870	\$970
48" w x 12" h	\$900	\$1,010
48" w x 14" h	\$910	\$1,030
48" w x 18" h	\$980	\$1,090
60" w x 12" h	\$940	\$1,110
60" w x 14" h	\$970	\$1,130
60" w x 18" h	\$1,040	\$1,210
72" w x 12" h	\$1,010	\$1,200
72" w x 14" h	\$1,130	\$1,320
72" w x 18" h	\$1,200	\$1,380

Custom sizes available - Use price from the next larger size. For example, 20" w x 12" h use pricing from the next larger size (24" w x 12" h)  
 Custom Fabric Upcharge: \$150 List handling fee. Customer required to purchase fabric COM (customer's own material).

## 1. PRODUCT CODE

Code	Description
TSF	Fabric   Frameless

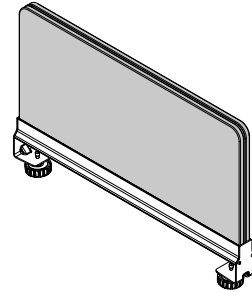

## 2. MOUNT

Code	Description
E1	Install TableScreen along the edge of a 7/8" to 1 3/16" thick table using an Edge Clamp.
E2	Install TableScreen along the edge of a 1 1/4" to 1 3/4" thick table using an Edge Clamp.
C1	Install TableScreen across a surface of a 7/8" to 1 3/16" thick table using a Cross Clamp.
C2	Install TableScreen across a surface of a 1 1/4" to 1 3/4" thick table using a Cross Clamp.
SM	Install TableScreen across a surface or along the edge of a table using a Surface Mount.
JC	Install TableScreen along the seams of two adjacent tables using a Joiner Clamp.

TableScreens

## 3. SURFACE

Code	Description
F	Fabric
For a full list of Standard and Grade A fabric options, visit <a href="https://egan.com/fabrics-and-textiles/">egan.com/fabrics-and-textiles/</a>	

## HOW TO ORDER

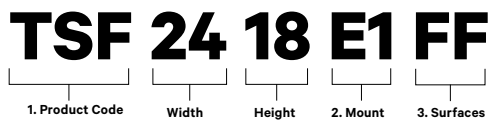

## Sound Ideas

Egan can provide a tailored sound analysis on how to reduce reverberation and decibels in your environment. Contact Egan or your local Rep for more details: [www.egan.com/rep-locator/](http://www.egan.com/rep-locator/)

### ■ Egan Disperse™

The all-new Egan Disperse™ Acoustical Panels gives you new ways to influence your space and enhance people's experience within it. Thanks to its sound-damping core (PET with an NRC rating of 0.75) and surface design, you have enhanced ability to influence sounds, particularly in open spaces. For a unique and highly customizable visual design element turn to Egan Disperse Acoustical Panels. Egan Disperse mobiles can help with sound mitigation in many environments. Front-facing apertures in the surface available in Egan's wood veneer for the infills, or specify Etex in a number of colors. Also available in wall mounted panels.

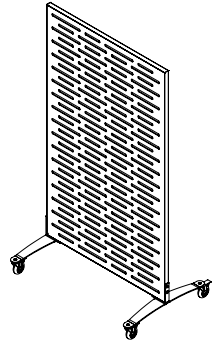

### ■ Acoustical Wall Panels

Form and function work together to provide visually interesting installations while reducing ambient noise and increasing workplace productivity. Egan acoustic panels are designed to help control echo and sound bounce within a room, and to stop sound from escaping or entering a room.

Series 3 panels are an ideal solution to effectively reducing dB levels in a room. These panels have an NRC rating of .85 (1") and 1.05 (2"). Specify your choice of acoustic fabric from Guilford of Maine, select Maharam, and COM fabrics.

### ■ Decorative Tack

Decorative Tack is designed for use on walls where a long lasting tackable surface is needed. While dampening noise, Decorative Tack can also be used as attractive, visual installations that add color and texture to a room. Available in 1/2" thickness with an NRC rating of .35 and STC rating of 25

# Egan Disperse™

Egan Disperse mobiles help with sound mitigation in open spaces. Thanks to its sound-damping core and surface design, you have enhanced ability to influence sounds. Front-facing apertures in the surface are available in Egan's wood or Etex in a number of colors.

DISPERSE MOBILE		
	Etex	Veneer
36"w x 54"h	\$2,960	\$3,280
48"w x 54"h	\$3,040	\$3,310
36"w x 60"h	\$3,100	\$3,450
48"w x 60"h	\$3,470	\$3,820
36"w x 72"h	\$3,140	\$3,560
48"w x 72"h	\$3,410	\$3,740

DISPERSE WALL MOUNT		
	Etex	Veneer
24"w x 36"h	\$880	\$950
48"w x 36"h	\$1,320	\$1,480
48"w x 48"h	\$1,530	\$1,690
60"w x 48"h	\$1,830	\$1,990
72"w x 48"h	\$2,200	\$2,360
96"w x 48"h	\$2,670	\$2,830

### 1. PRODUCT CODE

Code	Description
<b>SIM</b>	Disperse Mobile
<b>SIW</b>	Disperse Wall Mount

### 2. CORE FINISH

Code	Description
<b>T</b>	EcoTack   EganMetallic

### 3. SURFACE FINISH

Wood Veneer Stains	
Code	Description
<b>LO</b>	Light Oak
<b>MO</b>	Medium Oak
<b>DO</b>	Dark Oak
<b>BO</b>	Black Oak
<b>MA</b>	Mahogany
<b>CH</b>	Cherry
<b>MP</b>	Natural Maple
<b>WA</b>	Walnut
Custom Stain available Add \$300 to list, per item	

Etex Color Options	
Code	Description
<b>EM</b>	EganMetallic
<b>BL</b>	Black
<b>CL</b>	Charcoal
<b>GR</b>	Gray
<b>PT</b>	Platinum
<b>PY</b>	Putty
<b>SN</b>	Sand
<b>SL</b>	Slate
<b>TA</b>	Taupe
Custom Color available Add \$250 to list, per item	

### 4. FRAME COLOR

Code	Description	Price
<b>CA</b>	Clear Anodized	\$ 0
<b>WH</b>	White	\$ 150
<b>BL</b>	Black	\$ 150
<b>CC</b>	Custom Color	\$ 250

### 5. BASE COLOR

Mobile Only

Code	Description	Price
<b>CA</b>	Clear Anodized	\$ 0
<b>WH</b>	White	\$ 150
<b>BL</b>	Black	\$ 150
<b>CC</b>	Custom Color	\$ 250

### HOW TO ORDER

**SIM EB 36 72 WA WA CA EM**

1. Product Code    2. Core Finish    Width    Height    3. Surface Finish Side 1    Side 2    4. Frame Color    5. Base Color (Mobile only)

# Acoustical Panel System - Series 3

Series 3 panels are used extensively in auditoriums, conference rooms, offices, open plan areas, classrooms, and many other areas where the sound levels need adjusting. Designed to reduce dB levels, these acoustical panels have a NRC rating of .85 (1") and 1.05 (2").

### 1" Panel Thickness (Base list price Standard Fabric)

Inches	12"	18"	24"	30"	36"	42"	48"
12"	\$150	\$160	\$170	\$190	\$200	\$210	\$220
18"	\$160	\$180	\$190	\$210	\$230	\$250	\$270
24"	\$170	\$190	\$220	\$250	\$270	\$300	\$320
30"	\$190	\$210	\$250	\$280	\$300	\$340	\$360
36"	\$200	\$230	\$270	\$300	\$390	\$430	\$470
42"	\$210	\$250	\$300	\$340	\$430	\$520	\$560
48"	\$220	\$270	\$320	\$360	\$470	\$560	\$610
54"	\$240	\$290	\$340	\$430	\$520	\$600	\$650
60"	\$280	\$330	\$400	\$500	\$610	\$710	\$760
66"	\$320	\$380	\$450	\$560	\$680	\$810	\$870
72"	\$330	\$400	\$480	\$600	\$720	\$850	\$910
78"	\$340	\$420	\$500	\$630	\$760	\$890	\$950
84"	\$380	\$460	\$550	\$700	\$840	\$980	\$1,050
90"	\$420	\$510	\$600	\$760	\$910	\$1,070	\$1,150
96"	\$430	\$520	\$620	\$780	\$950	\$1,110	\$1,200
102"	\$500	\$600	\$750	\$850	\$1,020	\$1,150	\$1,250
108"	\$520	\$620	\$780	\$880	\$1,060	\$1,200	\$1,300
114"	\$530	\$640	\$800	\$920	\$1,090	\$1,240	\$1,340
120"	\$540	\$660	\$840	\$940	\$1,120	\$1,280	\$1,390

### 2" Panel Thickness (Base list price Standard Fabric)

Inches	12"	18"	24"	30"	36"	42"	48"
12"	\$150	\$160	\$180	\$190	\$210	\$220	\$230
18"	\$160	\$180	\$200	\$220	\$250	\$270	\$280
24"	\$180	\$200	\$230	\$260	\$280	\$310	\$340
30"	\$190	\$220	\$260	\$290	\$320	\$350	\$380
36"	\$210	\$250	\$280	\$320	\$410	\$460	\$490
42"	\$220	\$270	\$310	\$350	\$460	\$550	\$590
48"	\$230	\$280	\$340	\$380	\$490	\$590	\$640
54"	\$250	\$310	\$360	\$460	\$550	\$640	\$690
60"	\$290	\$350	\$420	\$520	\$640	\$740	\$810
66"	\$330	\$390	\$470	\$590	\$720	\$850	\$910
72"	\$340	\$420	\$500	\$630	\$760	\$900	\$960
78"	\$360	\$440	\$530	\$670	\$810	\$930	\$1,010
84"	\$390	\$490	\$580	\$730	\$890	\$1,030	\$1,110
90"	\$440	\$530	\$630	\$800	\$960	\$1,120	\$1,210
96"	\$450	\$550	\$660	\$830	\$1,000	\$1,170	\$1,260
102"	\$520	\$630	\$790	\$900	\$1,070	\$1,210	\$1,320
108"	\$540	\$650	\$810	\$930	\$1,110	\$1,270	\$1,370
114"	\$550	\$670	\$840	\$970	\$1,150	\$1,310	\$1,420
120"	\$560	\$690	\$880	\$1,000	\$1,190	\$1,350	\$1,470

### 1" Panel Thickness (Base list price Grade A Fabric)

Inches	12"	18"	24"	30"	36"	42"	48"
12"	\$230	\$230	\$250	\$260	\$280	\$290	\$300
18"	\$230	\$250	\$270	\$290	\$310	\$330	\$350
24"	\$250	\$270	\$300	\$320	\$350	\$380	\$400
30"	\$260	\$290	\$320	\$350	\$380	\$420	\$440
36"	\$280	\$310	\$350	\$380	\$510	\$550	\$580
42"	\$290	\$330	\$380	\$420	\$550	\$640	\$680
48"	\$300	\$350	\$400	\$440	\$580	\$680	\$720
54"	\$360	\$420	\$470	\$560	\$640	\$730	\$780
60"	\$400	\$460	\$520	\$620	\$740	\$830	\$890
66"	\$440	\$500	\$570	\$690	\$810	\$930	\$990
72"	\$470	\$540	\$620	\$740	\$860	\$990	\$1,050
78"	\$480	\$560	\$640	\$770	\$900	\$1,030	\$1,090
84"	\$520	\$600	\$690	\$840	\$980	\$1,120	\$1,190
90"	\$570	\$660	\$750	\$910	\$1,060	\$1,220	\$1,300
96"	\$580	\$680	\$780	\$940	\$1,100	\$1,260	\$1,350
102"	\$650	\$750	\$900	\$1,010	\$1,170	\$1,300	\$1,400
108"	\$700	\$800	\$950	\$1,060	\$1,230	\$1,380	\$1,470
114"	\$710	\$810	\$980	\$1,090	\$1,270	\$1,410	\$1,520
120"	\$720	\$840	\$1,010	\$1,120	\$1,300	\$1,450	\$1,560

### 2" Panel Thickness (Base list price Grade A Fabric)

Inches	12"	18"	24"	30"	36"	42"	48"
12"	\$230	\$240	\$260	\$270	\$290	\$300	\$310
18"	\$240	\$260	\$280	\$300	\$320	\$350	\$360
24"	\$260	\$280	\$310	\$340	\$360	\$390	\$420
30"	\$270	\$300	\$340	\$370	\$400	\$430	\$460
36"	\$290	\$320	\$360	\$430	\$530	\$570	\$610
42"	\$300	\$350	\$390	\$470	\$570	\$660	\$710
48"	\$310	\$360	\$420	\$500	\$610	\$710	\$750
54"	\$360	\$420	\$470	\$570	\$660	\$750	\$810
60"	\$410	\$480	\$540	\$650	\$770	\$870	\$930
66"	\$470	\$530	\$610	\$680	\$860	\$990	\$1,050
72"	\$480	\$560	\$640	\$730	\$900	\$1,030	\$1,100
78"	\$500	\$580	\$670	\$770	\$940	\$1,070	\$1,150
84"	\$550	\$640	\$740	\$880	\$1,040	\$1,180	\$1,270
90"	\$590	\$680	\$780	\$950	\$1,110	\$1,270	\$1,370
96"	\$600	\$700	\$810	\$980	\$1,150	\$1,320	\$1,410
102"	\$700	\$810	\$960	\$1,080	\$1,250	\$1,390	\$1,500
108"	\$720	\$830	\$990	\$1,110	\$1,290	\$1,440	\$1,550
114"	\$730	\$840	\$1,020	\$1,140	\$1,330	\$1,490	\$1,600
120"	\$750	\$880	\$1,070	\$1,190	\$1,380	\$1,540	\$1,660

Custom sizes available - Select next larger size and add \$250 to list / item

Custom Fabric Upcharge: \$150 List handling fee. Customer required to purchase fabric COM (customer's own material).

# Acoustical Panel System - Series 3

## 1. PRODUCT CODE

Code	Description
SIAPS31	Acoustical Panel System - 3 1"
SIAPS32	Acoustical Panel System - 3 2"

## 3. EDGE DETAIL

Code	Description
S	Square

## 2. MOUNTS

Code	Mount Option	Price
Z	Z-Clip	\$ 70
I	Impaling Clip	Spot Quote - Call CS
V	Velcro	Spot Quote - Call CS

## 4. CORNER DETAIL

Code	Description
S	Square

## RATINGS

Noise Reduction Coefficient - NRC	
1"	.85
2"	1.05

## 5. FABRIC

Acoustic Fabrics - included in list price
FR701 (Style 2100)
Anchorage (Style 2977)
Crosstown (Style 5118)
Marin (Style 1300)
Resolve (Style 1300)
For a full list of Acoustic and Grade A fabric options, visit <a href="https://egan.com/fabrics-and-textiles/">egan.com/fabrics-and-textiles/</a>

Grade A Fabrics
Manner (466177)
Metric (466914)
Muse (466487)
Meld (466387)
Murmur (466446)
For a full list of Acoustic and Grade A fabric options, visit <a href="https://egan.com/fabrics-and-textiles/">egan.com/fabrics-and-textiles/</a>

## HOW TO ORDER

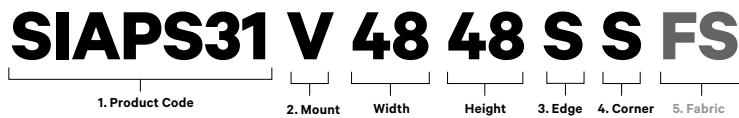

# Decorative Tack Panel

Decorative Tack Panel can be used as a tackable surface or purely visual piece adding color, texture, and added STC to a room. Conference rooms, classrooms, offices and hospital patient rooms are just a few perfect applications for these panels.

### 1/2" Panel Thickness (Base list price Standard Fabric)

Inches	12"	18"	24"	30"	36"	42"	48"
12"	\$140	\$150	\$160	\$180	\$190	\$210	\$220
18"	\$150	\$170	\$190	\$210	\$220	\$250	\$270
24"	\$160	\$190	\$210	\$240	\$260	\$290	\$310
30"	\$180	\$210	\$240	\$270	\$300	\$330	\$360
36"	\$190	\$220	\$260	\$300	\$380	\$420	\$460
42"	\$210	\$250	\$290	\$330	\$420	\$510	\$550
48"	\$220	\$270	\$310	\$360	\$460	\$550	\$590
54"	\$230	\$280	\$340	\$420	\$510	\$590	\$640
60"	\$270	\$330	\$390	\$490	\$600	\$690	\$750
66"	\$300	\$370	\$440	\$550	\$670	\$780	\$840
72"	\$310	\$390	\$470	\$590	\$700	\$830	\$900
78"	\$330	\$400	\$500	\$620	\$750	\$870	\$940
84"	\$370	\$450	\$540	\$680	\$820	\$950	\$1,030
90"	\$410	\$490	\$590	\$740	\$890	\$1,040	\$1,120
96"	\$420	\$510	\$610	\$770	\$920	\$1,080	\$1,170
102"	\$480	\$580	\$730	\$840	\$1,000	\$1,130	\$1,220
108"	\$500	\$600	\$750	\$860	\$1,030	\$1,170	\$1,270
114"	\$510	\$620	\$780	\$900	\$1,070	\$1,210	\$1,320
120"	\$520	\$640	\$810	\$920	\$1,100	\$1,250	\$1,360

### 1/2" Panel Thickness (Base list price Grade A Fabric)

Inches	12"	18"	24"	30"	36"	42"	48"
12"	\$220	\$230	\$240	\$250	\$270	\$290	\$300
18"	\$230	\$250	\$260	\$290	\$300	\$320	\$350
24"	\$240	\$260	\$290	\$320	\$340	\$370	\$390
30"	\$250	\$290	\$320	\$350	\$380	\$410	\$440
36"	\$270	\$300	\$340	\$380	\$500	\$540	\$570
42"	\$290	\$320	\$370	\$410	\$540	\$620	\$660
48"	\$300	\$350	\$390	\$440	\$570	\$660	\$710
54"	\$360	\$410	\$460	\$550	\$630	\$720	\$770
60"	\$390	\$450	\$520	\$610	\$720	\$820	\$870
66"	\$430	\$490	\$560	\$680	\$790	\$910	\$970
72"	\$450	\$530	\$610	\$730	\$840	\$970	\$1,040
78"	\$470	\$540	\$640	\$760	\$880	\$1,010	\$1,080
84"	\$510	\$590	\$680	\$820	\$960	\$1,090	\$1,170
90"	\$560	\$640	\$740	\$890	\$1,040	\$1,190	\$1,270
96"	\$570	\$660	\$760	\$920	\$1,080	\$1,230	\$1,320
102"	\$630	\$740	\$880	\$990	\$1,150	\$1,280	\$1,370
108"	\$680	\$780	\$930	\$1,040	\$1,210	\$1,350	\$1,450
114"	\$690	\$800	\$950	\$1,070	\$1,240	\$1,390	\$1,500
120"	\$700	\$820	\$990	\$1,100	\$1,280	\$1,430	\$1,540

Custom sizes available - Select next larger size and add \$250 to list / item  
 Custom Fabric Upcharge: \$150 List handling fee. Customer required to purchase fabric.

<b>1. PRODUCT CODE</b>	<table border="1"> <thead> <tr> <th>Code</th> <th>Description</th> </tr> </thead> <tbody> <tr> <td>SIDT</td> <td>Decorative Tack Panel</td> </tr> </tbody> </table>	Code	Description	SIDT	Decorative Tack Panel	<b>3. EDGE DETAIL</b>	<table border="1"> <thead> <tr> <th>Code</th> <th>Description</th> </tr> </thead> <tbody> <tr> <td>S</td> <td>Square</td> </tr> </tbody> </table>	Code	Description	S	Square			
Code	Description													
SIDT	Decorative Tack Panel													
Code	Description													
S	Square													
<b>2. MOUNTS</b>	<table border="1"> <thead> <tr> <th>Code</th> <th>Mount Option</th> <th>Price</th> </tr> </thead> <tbody> <tr> <td>Z</td> <td>Z-Clip</td> <td>\$ 70</td> </tr> </tbody> </table>	Code	Mount Option	Price	Z	Z-Clip	\$ 70	<b>4. CORNER DETAIL</b>	<table border="1"> <thead> <tr> <th>Code</th> <th>Description</th> </tr> </thead> <tbody> <tr> <td>S</td> <td>Square</td> </tr> </tbody> </table>	Code	Description	S	Square	
Code	Mount Option	Price												
Z	Z-Clip	\$ 70												
Code	Description													
S	Square													
<b>5. FABRIC</b>	<p><b>Acoustic Fabrics - included in list price</b></p> <p>FR701 (Style 2100)</p> <p>Anchorage (Style 2977)</p> <p>Crosstown (Style 5118)</p> <p>Marin (Style 1300)</p> <p>Resolve (Style 1300)</p> <p>For a full list of Acoustic and Grade A fabric options, visit <a href="http://egan.com/fabrics-and-textiles/">egan.com/fabrics-and-textiles/</a></p>	<p><b>Grade A Fabrics</b></p> <p>Manner (466177)</p> <p>Metric (466914)</p> <p>Muse (466487)</p> <p>Meld (466387)</p> <p>Murmur (466446)</p> <p>For a full list of Acoustic and Grade A fabric options, visit <a href="http://egan.com/fabrics-and-textiles/">egan.com/fabrics-and-textiles/</a></p>	<b>RATINGS</b>	<table border="1"> <thead> <tr> <th>NRC Rating</th> <th>STC Rating</th> </tr> </thead> <tbody> <tr> <td>.35</td> <td>25</td> </tr> </tbody> </table>	NRC Rating	STC Rating	.35	25						
NRC Rating	STC Rating													
.35	25													

**HOW TO ORDER**

# SIDT 48 48 Z S S F

1. Product Code

Width

Height

2. Mount

3. Edge

4. Corner

5. Fabric

Sound Ideas



## ■ Technology

---

Egan's technology lecterns blend contemporary design with logical technology management. Our lecterns inspire confidence and give you control of your presentation without the need for a mouse, remote or keyboard. Our lecterns range in features and benefits such as dynamic height adjustment, interactive touch screens, and customizable design specifications.

## ■ Contemporary

---

These elegant lecterns are built for a range of benefits, such as easy mobility, height adjust-ability, as well as ample and lockable storage. These lecterns are built for durability, are light weight and known for their portability. These Contemporary lecterns are popular for modern business presentations, school presentations, art shows, and any setting that calls for an attractive looking presentation.

## ■ Classic

---

Like our Contemporary lecterns, Egan Classic lecterns are designed for settings that call for an attractive looking presentation. These lecterns are popular for customer's choice in wood surface finish and custom printed graphics. Our classic lecterns are also known for their range of features, such as mobility and height adjust-ability.

# LECTERNS

**BUILT  
TO INSPIRE**

# How to Choose an Egan Lectern

Egan Visual offers an exceptional array of lecterns and presentation centers for any environment that calls for spoken presentations and focused information sharing. Our lecterns range from the beautiful and highly practical AVA Lectern with its endless standard configurations to our attractive and technologically sophisticated TecTern™ Series.

Here are some things to keep in mind when considering which Egan lectern is right for your space:

---

## Esthetic

- Does your space require a Classic, Contemporary or a Technology lectern design?
- Is there a requirement for custom logos or graphics on the modesty facing or any other part of your Egan lectern?
- What finishes does your design palette call for?

## The Presenter

- Is it important that your Egan lectern is height adjustable and/or ADA/barrier free for accessibility and comfort?
- Is it preferable that your Egan lectern include hand placement channels on the crown for the speaker's comfort?
- Do you expect a variety of media and presentation methods to be deployed from your Egan lectern (eg: printed notes, projection/document camera)

## Utility

- Will your presenters be using a laptop, tablet, or other device to deliver their message be installed in or around your Egan lectern?
- Does your environment require that your Egan lectern be fully mobile and able to move easily from area to area with locking casters?
- Are there any number of audio-visual components that need to be added to your Egan lectern at the time of installation? (eg: racked equipment, room control components)

## Places

Egan lecterns can be used to stand out in a variety of places and situations, including: boardrooms, project rooms, lecture halls, places of worship, banquet halls, and hotels. They are also ideal for valets and maître d's to greet guests. You can use your Egan lectern for whatever the situation calls for; the only limit is your creativity.

Everything you see in the following section of this Egan Price & Specification Guide is available as a standard product, a custom configured product with a host of elements to choose from, as well as fully bespoke lecterns and presentation centers that can be designed in partnership with you and our factory experts through our industry leading Custom Response Program.

# Audio Visual Height Adjustable Lectern

The AVA lectern is a height-adjustable podium with an elegant, modern design. Finished in wood veneer and powder-coated base and top, the AVA lectern comes with various key features to support you through your presentations. Some key features include a power height adjustment from 31-1/2" to 42-3/8," built-in wheels on base for mobility, pull-out shelf, and a 1 3/4" diameter holes for cabling, monitor arm, microphone restraint or in/out cabling. ADA Compliant.

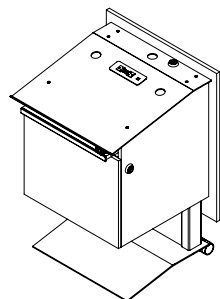

Dimensions	Price
Upper Position: 42 1/8"h to 27 1/2"w	\$9,460
Lower Position: 31 1/2"h to 27 1/2"w	
Worksurface: 25 1/4"l x 27 1/2"w	
Inside Clearance: 17 1/2"h x 16 3/4"w	

## 1. PRODUCT CODE

Code	Description
AVA	AVA Lectern

## 2. BODY FINISH

Light Oak	Medium Oak	Dark Oak	Black Oak	Cherry	Mahogany	Natural Maple	Walnut
LO	MO	DO	BO	CH	MA	MP	WA

Custom Stain available - Add \$300 to list, per item

## 3. TOP, FRAME & BASE

White	Grey	Black
WH	GR	BL

## 4. OPTIONS

Code	Description	Price
RS	AV Rack and Adjustable Shelf	\$320

## HOW TO ORDER

# AVA MO BL

1. Product Code      2. Body Finish      2. Finish

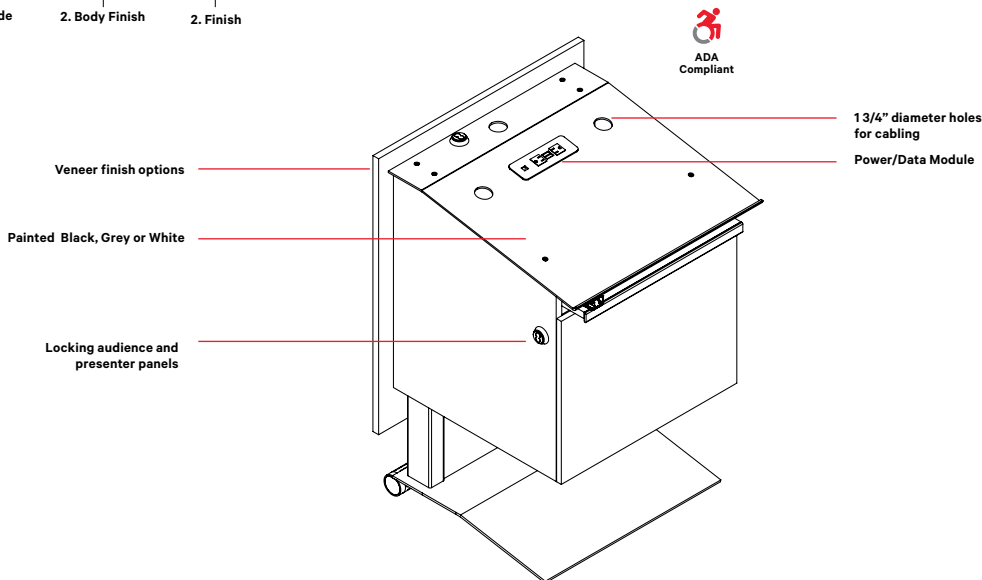

# TecTern™ III

TecTern™ III brings a decidedly modern and sleek esthetic to the Egan technology lectern series. With soaring lines and swooping expanses of clean space, TecTern III makes an intelligent statement about the presenter and the presentation. Interactive presentations are easy, with a fully-integrated interactive flat panel - finger touch control that even guest presenters can use, because it connects to the PC with no drivers to install. T3TM includes annotation software.

Description	Dimensions	Price
TecTern III with laptop shelf.	24 5/8"w x 43 3/4"h x 25 9/16"d	\$4,600
TecTern III with Finger Touch Monitor.	24 5/8"w x 43 3/4"h x 25 9/16"d	\$8,240

Monitor has a limited 90 day warranty, including back light

## 1. PRODUCT CODE

Code	Description
<b>T3LS</b>	TecTern III with laptop shelf.
<b>T3TM</b>	TecTern III with Finger Touch Monitor.

## 2. WORK SURFACE & BODY FINISH

Code	Description	
<b>WH<sup>1</sup></b>	White (non-textured) - White Etex Work Surface	<sup>1</sup> Default finish Standard: Locks on presenter side cabinet doors, casters, 19" industry standard AV rack with one shelf Custom color not available
<b>GM</b>	Gunmetal Gray (textured) - Charcoal Etex Work Surface	
<b>EM</b>	EganMetallic (textured) - EganMetallic Etex Work Surface	
<b>BL</b>	Black (textured) - Black Etex Work Surface	

## 3. OPTIONS

Code	Description	Price
<b>B</b>	Light - 12" electric goose neck lamp complete with dimmer switch.	\$240
<b>CH</b>	Cup Holder	\$50
<b>T</b>	Clock <sup>1</sup>	\$210

<sup>1</sup> Clock (T) is liquid crystal display with front control buttons. The clock is flush mounted. Battery included.

## HOW TO ORDER

# T3TM WH CH

1. Product Code

2. Body Finish

3. Options

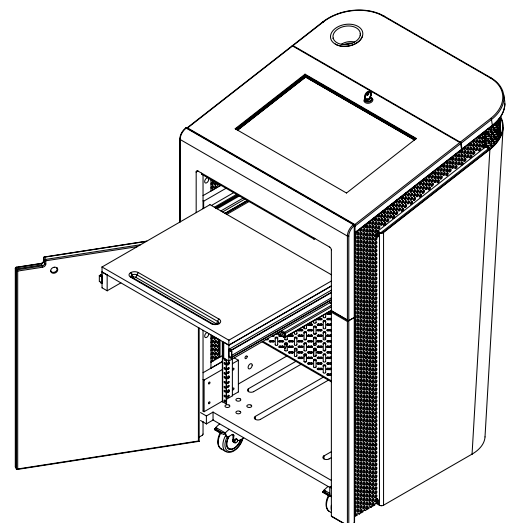
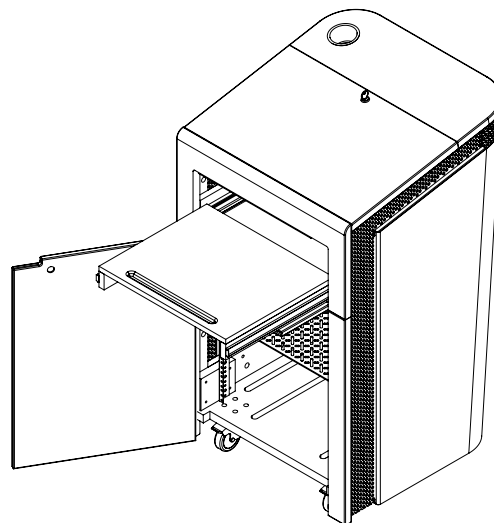

# TecTern™ S2

The popular TecTern™ series takes inspiration from the highly customizable 202 series instruction lecterns, bringing high functionality in a contemporary design and modest footprint. TecTern S2 features the size-class of TecTern TWO, but introduces a base and crown that can be specified to your needs. Highly tech friendly, beginning with space for a laptop. Tech is accessible with front and back access panels. At the side, slide out the integrated visualizer deck for comprehensive presentations.

Crown	Lower Cabinet	Price	
Etex	Etex	\$3,630	† Two Custom Colors in any combination
Etex	Veneer	\$4,550	Front and back cabinet door locks, casters, 19" industry standard AV rack with one shelf

## 1. PRODUCT CODE

Code	Description	Dimensions
<b>S2LS</b>	TecTern S2 with laptop shelf (LS)	24 1/2"w x 44 1/2"h x 23 1/2"d

## 2. CROWN FINISH

Etex Finish

EganMetallic	Black	Charcoal	Gray	Platinum	Putty	Sand	Slate	Taupe	Custom Color
EM	BL	CL	GR	PT	PY	SN	SL	TA	CC

Custom Color - Add \$250 per list/item.

## 3. BODY FINISH

Etex Finish

EganMetallic	Black	Charcoal	Gray	Platinum	Putty	Sand	Slate	Taupe	Custom Color
EM	BL	CL	GR	PT	PY	SN	SL	TA	CC

Custom Color - If matching Custom Color Crown no additional upcharge. Is selecting second/new custom color add \$250 list/item.

Wood Veneer

Light Oak	Medium Oak	Dark Oak	Black Oak	Cherry	Mahogany	Natural Maple	Walnut
LO	MO	DO	BO	CH	MA	MP	WA

Custom Stain available - Add \$300 to list, per item

## 3. OPTIONS

Code	Description	Price
<b>B</b>	Light - 12" electric goose neck lamp complete with dimmer switch.	\$240
<b>T</b>	Clock <sup>2</sup>	\$210
<b>M</b>	Audience facing digital monitor	\$1,110

<sup>2</sup> Liquid Crystal Display clock with front control buttons. The clock is flush mounted in the top right corner of the crown support. Battery included.

## HOW TO ORDER

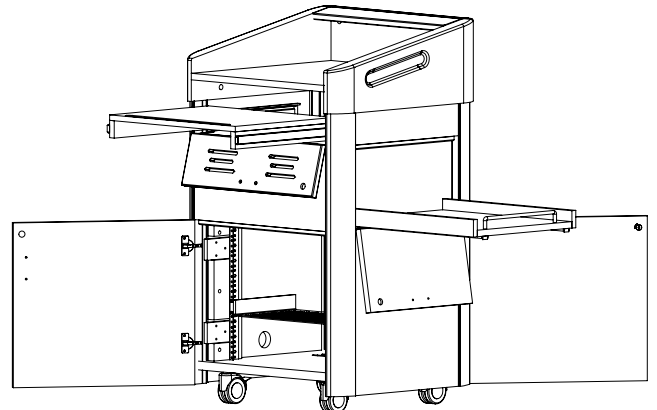
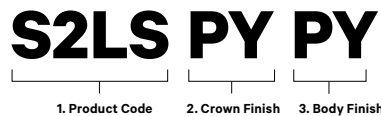

Lecterns

# TecTern™ TWO

TecTern™ TWO features the sleek design made popular by TecTern and features a fixed-height crown with ample storage space, laptop tray, storage area with flip-down access panel, drawer, lower cabinet with rails for rack-mounted equipment and a shelf for non-racked equipment. TM model features a VGA adapter. TecTern TWO adds functionality to make your presentations come alive with digital annotations and more, all with the touch of a finger. T2TM includes annotation software.

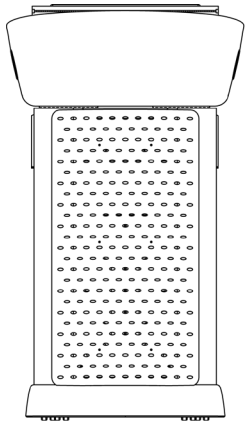

Front

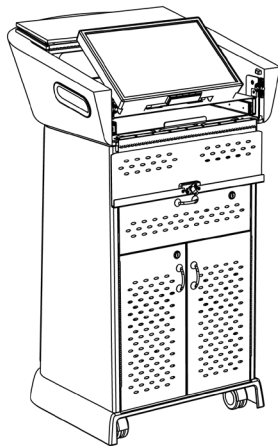

Back

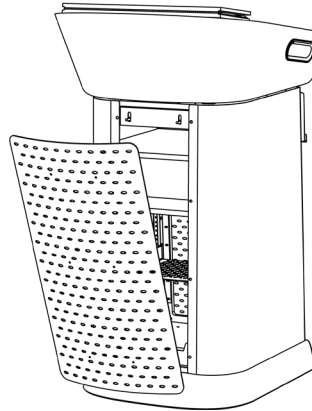

Front Access

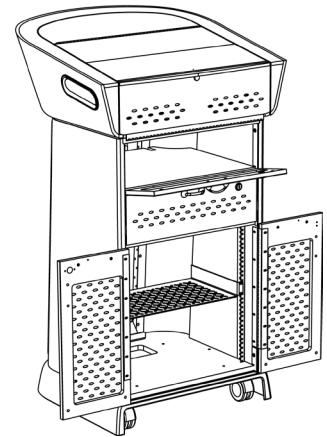

Back Access

## 1. Choose your Technology Package

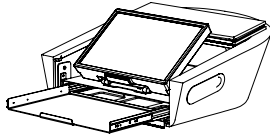
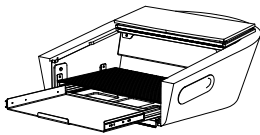

Code	Description	Dimensions	Price
T2LS	Laptop Shelf (LS)	27 1/2"w x 47"h x 25"d	\$6,990
T2TM	Finger Touch Monitor* (TM)		\$10,610

\* Ships with annotation software. Monitor has a limited 90 day warranty, including back light

## 2. Choose TecTern Crown Color

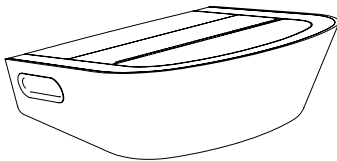

EganMetallic	Black	Charcoal	Gray	Platinum
EM	BL	CL	GR	PT

  

Putty	Sand	Slate	Taupe	Custom Color
PY	SN	SL	TA	CC - \$250

## 3. Chassis Color\*

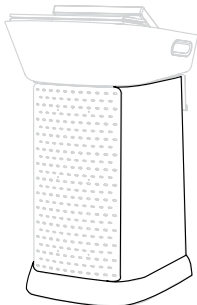

\*Chassis Color is standard Gunmetal

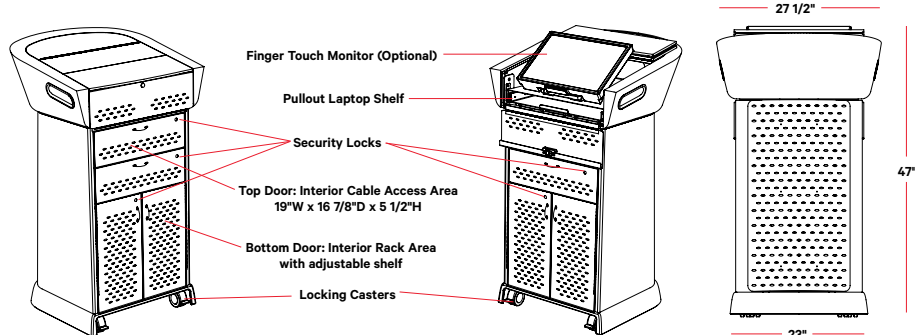

# TecTern™ TWO

## 4. Facing Panel Options

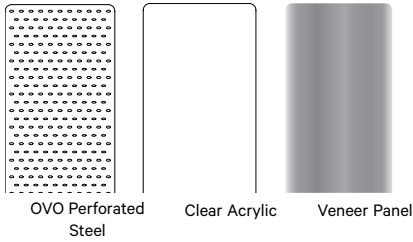

OVO Perforated Steel      Clear Acrylic      Veneer Panel

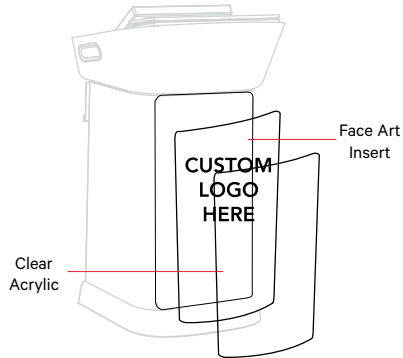

Code	Description	Price
OV	OVO Perforated Steel	\$0
AC	Clear Acrylic*	\$320
VP	Veneer Panel	\$590

\* May be paired with Modesty Face Art insert

## OV and AC Modesty Facing Finish Color

EganMetallic	Black	Charcoal	Gray	Platinum
EM	BL	CL	GR	PT

Putty	Sand	Slate	Taupe	Custom Color
PY	SN	SL	TA	CC

\$250 per color if Custom Color (CC) option selected

## Veneer Modesty Face Finish

Classic Veneer				Modern Veneer
Light Oak	Medium Oak	Dark Oak	Black Oak	Gray Oak
LO	MO	DO	BO	GO

Cherry	Mahogany	Natural Maple	Walnut
CH	MA	MP	WA

\$300 per color if Custom Stain (CS) option selected

## 5. Facing Art Insert



Code	Description	Price
G	Custom art (EganINK) printed to fit 17" x 32" AC Front Facing Required	\$ 480

Not available with Veneer Panel or OVO Perforated Steel Option

## 6. Light, Optional



Code	Description	Price
B	Light - 12" electric goose neck lamp complete with dimmer switch.	\$ 240

## 7. Custom Logo Options

Code	Description	Price
T	Custom Logo, 3D installed or custom built	Call Inside Sales

## Your Code Is



TecTern  
TWO Lectern  
Technology  
Integration

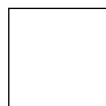

Crown Color

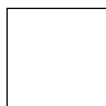

Facing Panel  
Option

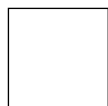

Modesty  
Facing Finish  
Color

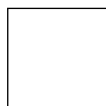

Veneer Panel  
Finish



Front Facing  
Art Insert



Light

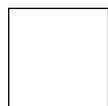

Custom Logo

NOTE: Custom Color fee \$250 applies per color. Additional use of same color on different components are no charge for subsequent use of same color

Electronically height adjustable for universal access and A.D.A. friendliness, the TecTern™ creates opportunities for exciting presenter-audience interaction. Features include an optional built-in finger-touch monitor that allows you to control your presentation directly from TecTern. Interactive presentations are now possible in lecture halls, theatres, and other large-audience settings. TecTern adds functionality to make your presentations come alive with digital annotations and more, all with the touch of a finger. TLTM includes annotation software.

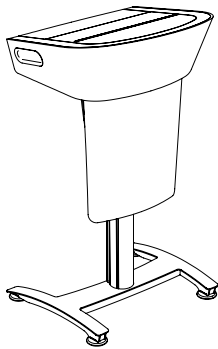

TecTern with Laptop Shelf

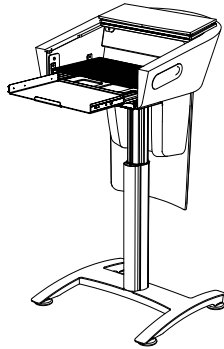

TecTern with Finger Touch Monitor

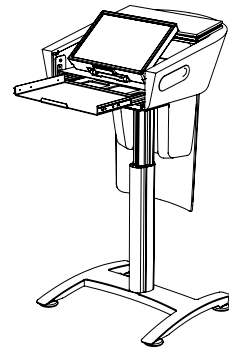
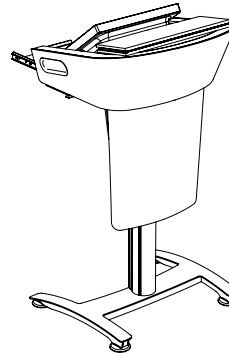

**1. Choose your Technology Package**

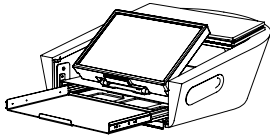

Code	Description	Dimensions	Price
TLLS	Laptop Shelf (LS)	29 1/4"w x 39"h (min) / 51"h (max) x 26 5/8"d	\$7,410
TLTM	Finger Touch Monitor* (TM)		\$11,460

\* Ships with annotation software. Monitor has a limited 90 day warranty, including back light. Electric lift motor has a one-year warranty

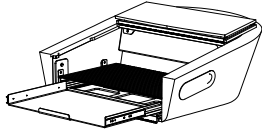

**2. Choose TecTern Crown Color**

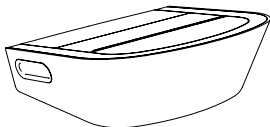

EganMetallic	Black	Charcoal	Gray	Platinum
EM	BL	CL	GR	PT
Putty	Sand	Slate	Taupe	Custom Color
PY	SN	SL	TA	CC

\$250 per color if Custom Color (CC) option selected

**3. Choose Modesty Panel**

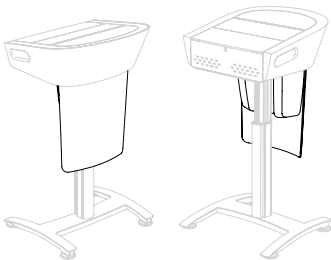

EganMetallic	Black	Charcoal	Gray	Platinum
EM	BL	CL	GR	PT
Putty	Sand	Slate	Taupe	Custom Color
PY	SN	SL	TA	CC

\$250 per color if Custom Color (CC) option selected



**4. Modesty Facing Options**

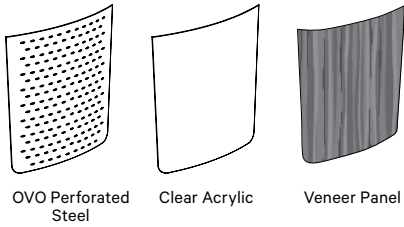

OVO Perforated Steel    Clear Acrylic    Veneer Panel

Code	Description	Price
<b>OV</b>	OVO Perforated Steel	\$440
<b>AC</b>	Clear Acrylic*	\$340
<b>VP</b>	Veneer Panel	\$630
<b>BP</b>	Basic Panel, No Facing	\$ 0

\* May be paired with Modesty Face Art insert

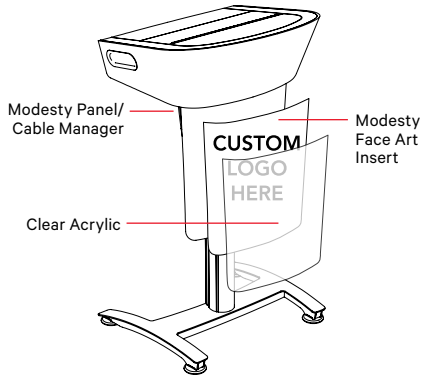

EganMetallic	Black	Charcoal	Gray	Platinum
EM	BL	CL	GR	PT

Putty	Sand	Slate	Taupe	Custom Color
PY	SN	SL	TA	CC

\$250 per color if Custom Color (CC) option selected

**Veneer Modesty Face Finish**

**Classic Veneer**

Light Oak	Medium Oak	Dark Oak	Black Oak
LO	MO	DO	BO

**Modern Veneer**

Gray Oak
GO

Cherry	Mahogany	Natural Maple	Walnut
CH	MA	MP	WA

\$300 per color if Custom Stain (CS) option selected

**5. Modesty Facing Art Insert**



Code	Description	Price
<b>G</b>	Custom art (EganINK) printed to fit 17 1/2" x 21 1/2" AC Modesty Facing Required	\$ 480

Not available with Veneer Panel, OVO Perforated Steel, & Basic Panel Option.

**6. Light, Optional**



Code	Description	Price
<b>B</b>	Light - 12" electric goose neck lamp complete with dimmer switch.	\$ 240

**7. Custom Logo Options**

Code	Description	Price
<b>T</b>	Custom Logo, 3D installed or custom built	Call Customer Service.

**Your Code Is**



**TLLS**  
TecTern Lectern Technology Integration



Crown Color



Modesty Panel/Cable Manager color



Modesty Facing Material



Modesty Facing Finish Color



Veneer Panel Finish



Modesty Facing Art Insert



Light



Custom Logo

# 202 EganLectern

The Classic 'Front of House' lectern updated with the 202 design. Aluminum extrusions frame your choice of real wood veneer or durable Etex finish. Lockable storage and wiring grommets for field set-up of laptops, tablets and microphone. A 17° angled surface with a lip on the bottom is suitable for reference notes. Two casters on the presenter's side assure the lectern can only be moved by tipping the unit onto the casters. This design prevents 'run-away' when you lean upon the lectern.

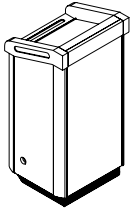

Crown	Lower Cabinet	S2LF Price	
Etex	Etex	\$2,890	Lower cabinet with lock and adjustable shelf 13/4" ID.
Etex	Veneer	\$4,040	Grommets on both sides and top worksurface Finish Options: Model may be specified with different finish combinations.

## 1. PRODUCT CODE

Code	Description	Dimensions
S2LF	202 Egan Lectern	24"w x 48"h x 21"d

## 2. CROWN FINISH

Etex Finish

EganMetallic	Black	Charcoal	Gray	Platinum	Putty	Sand	Slate	Taupe	Custom Color
EM	BL	CL	GR	PT	PY	SN	SL	TA	CC

Custom Color - Add \$250 per list/item.

## 3. BODY FINISH

Etex Finish

EganMetallic	Black	Charcoal	Gray	Platinum	Putty	Sand	Slate	Taupe	Custom Color
EM	BL	CL	GR	PT	PY	SN	SL	TA	CC

Custom Color - If matching Custom Color Crown no additional upcharge. Is selecting second/new custom color add \$250 list/item.

Wood Venerer

Light Oak	Medium Oak	Dark Oak	Black Oak	Cherry	Mahogany	Natural Maple	Walnut
LO	MO	DO	BO	CH	MA	MP	WA

Custom Stain available - Add \$300 to list, per item

## 4. OPTIONS



Code	Price	Description
B	\$240	Light - 12" electric goose neck lamp complete with dimmer switch.
T	\$210	Clock - Liquid Crystal Display clock with front control buttons. The clock is flush-mounted in the top right corner of the crown support. Battery included.

## HOW TO ORDER

# S2LF PT PT BT

1. Product Code    2. Crown Finish    3. Body Finish    4. Options

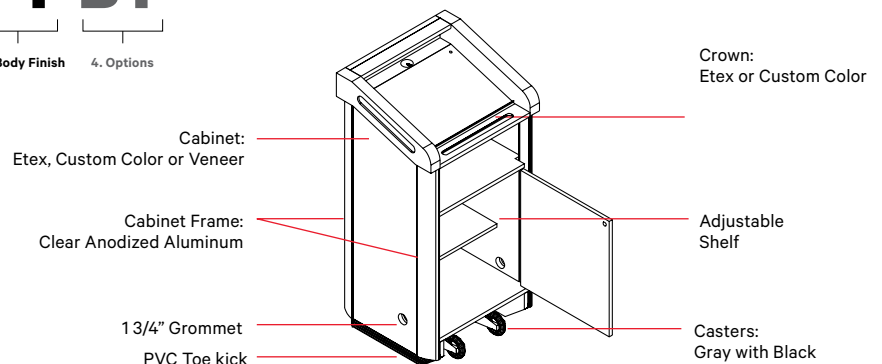

# 202 Mobile Instruction Center

202 Mobile Instruction Centers are technology-driven lecterns, well suited for specialized requirements. Shelf space accommodates computers and other presentation media equipment. A large drawer accommodates document cameras or overhead/data projectors.

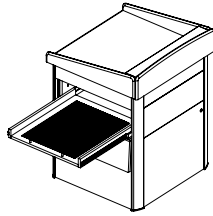

Crown	Lower Cabinet	Price	
Etex	Etex	\$6,570	Aluminum extrusion "bumper" corners to help prevent damage when moving Large worksurface provides ample space for a monitor/ reference material The front panel opens for access to two, supplied 6-outlet powerstrips An articulating arm supports a keyboard and mouse pad Worksurface: 32" w x 25" d Drawer: 23 1/4" w x 8 1/4" h x 27" d Equipment Storage Area: 26" w x 20" h x 28" d (with 2 adjustable shelves) Grommets located on upper crown facing and bottom shelf with 2 1/4" ID
Etex	Veneer	\$8,720	

## 1. PRODUCT CODE

Code	Description	Dimensions
<b>S2IM</b>	202 Mobile Instruction Center	34" w x 47 1/2" h x 32 1/2" d

## 2. CROWN FINISH

**Etex Finish**

EganMetallic	Black	Charcoal	Gray	Platinum	Putty	Sand	Slate	Taupe	Custom Color
EM	BL	CL	GR	PT	PY	SN	SL	TA	CC

Custom Color - Add \$250 per list/item.

## 3. BODY FINISH

**Etex Finish**

EganMetallic	Black	Charcoal	Gray	Platinum	Putty	Sand	Slate	Taupe	Custom Color
EM	BL	CL	GR	PT	PY	SN	SL	TA	CC

Custom Color - If matching Custom Color Crown no additional upcharge. Is selecting second/new custom color add \$250 list/item.

**Wood Veneer**

Light Oak	Medium Oak	Dark Oak	Black Oak	Cherry	Mahogany	Natural Maple	Walnut
LO	MO	DO	BO	CH	MA	MP	WA

Custom Stain available - Add \$300 to list, per item

## 4. OPTIONS

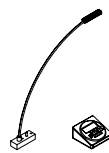

Code	Price	Description
<b>B</b>	\$240	Light - 12" electric goose neck lamp complete with dimmer switch.
<b>T</b>	\$210	Clock/Timer - Liquid Crystal Display clock with front control buttons. The clock is flush-mounted in the top right corner of the crown support. Battery included.

## HOW TO ORDER



To specify S2IM with multiple finishes or colors please note:

- Both Crown (Top) and body require finish specifications
- Crown is available in Etex and Custom Color only
- Body (Base) is available in Etex, Custom Color, Wood Veneer and Custom Stain
- For Custom Color, specify your desired color
- Custom applications of this product are very popular; see Custom Response (page 94)

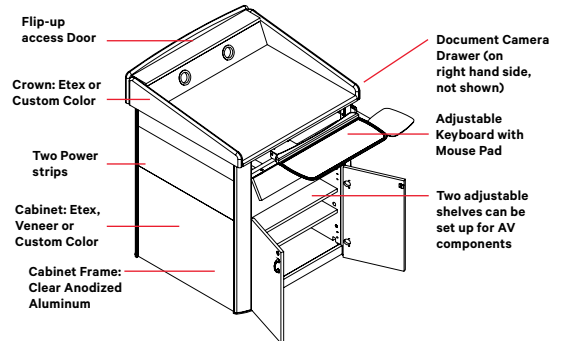

# 202 ADA

Height-adjustable 202 ADA Lectern is equipped with a push button, electric-lift mechanism that adjusts the working height 34"-44". Inside clearance accommodates wheelchair access and complies with universal design and the Americans with Disabilities Act. Wiring grommets for field setup of laptops, tablets and microphone.

## 1. PRODUCT CODE

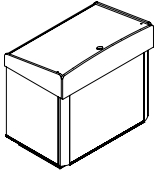

Code	Dimensions
<b>S2LH</b>	Upper-Height Position: 39"w x 44"h x 25"d
	Lower-Height Position: 39"w x 34"h x 25"d
	Worksurface: 38"w x 24"d
	Inside Clearance: 30"w x 24"d

Crown	Lower Cabinet	S2LH Price
Etex	Etex	\$6,800
Etex	Veneer	\$10,340

2" locking casters for easy mobility  
 Electric lift motor has a one-year warranty  
 Aluminium extrusion "bumper" corners help prevent damage when moving

## 2. CROWN FINISH

### Etex Finish

EganMetallic	Black	Charcoal	Gray	Platinum	Putty	Sand	Slate	Taupe	Custom Color
EM	BL	CL	GR	PT	PY	SN	SL	TA	CC

Custom Color - Add \$250 per list/item.

## 3. BODY FINISH

### Etex Finish

EganMetallic	Black	Charcoal	Gray	Platinum	Putty	Sand	Slate	Taupe	Custom Color
EM	BL	CL	GR	PT	PY	SN	SL	TA	CC

Custom Color - If matching Custom Color Crown no additional upcharge. Is selecting second/new custom color add \$250 list/item.

### Wood Vener

Light Oak	Medium Oak	Dark Oak	Black Oak	Cherry	Mahogany	Natural Maple	Walnut
LO	MO	DO	BO	CH	MA	MP	WA

Custom Stain available - Add \$300 to list, per item

## 4. OPTIONS

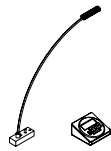

Code	Price	Description
<b>B</b>	\$240	Light - 12" electric goose neck lamp complete with dimmer switch.
<b>T</b>	\$210	Clock/Timer - Liquid Crystal Display clock with front control buttons. The clock is flush-mounted in the top right corner of the crown support. Battery included.

## HOW TO ORDER

# S2LH PT MP BT

1. Product Code    2. Crown Finish    3. Body Finish    4. Options

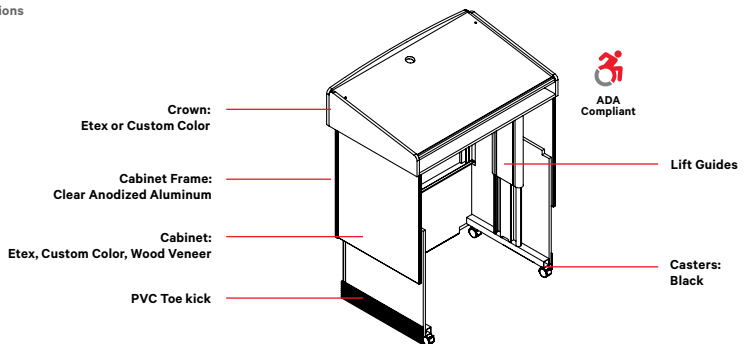

# OVO

Egan's commitment to design is showcased in this exciting aluminum lectern. Soft rubber grips keep the presenter firmly connected to their presentation. The document platform is an angled surface with a lip at the front and is suitable for reference notes, includes soft rubber grips, and is height-adjustable 37" h–40" h. Adjusts to horizontal for laptop use. The perforated steel front available in any of our Smooth Etex finishes. The front panel is available in wood veneer.

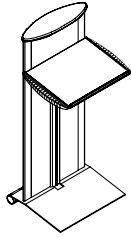

Dimensions	Etex	Veneer	
22 1/2" w x 49" h x 21" d	\$3,420	\$3,820	Document Shelf: Angled 19" w x 15" d with lip to keep notes in place Below Shelf Storage: 13" w x 4" d (reduces to 1" d at front) Height-adjustable document platform adjusts from 37" h to 40" h Document Platform, Crown and Casters finished black only

## 1. PRODUCT CODE

Code	Description
OVLW	OVO Lectern

## 2. FINISH

Etex Finish

EganMetallic	Black	Charcoal	Gray	Platinum	Putty	Sand	Slate	Taupe
EM	BL	CL	GR	PT	PY	SN	SL	TA

Smooth Etex finish is available only on perforated front panel. Solid back panel is black only

Custom Color available - Add \$250 to list, per item

Wood Veneer

Light Oak	Medium Oak	Dark Oak	Black Oak	Cherry	Mahogany	Natural Maple	Walnut
LO	MO	DO	BO	CH	MA	MP	WA

Custom Stain available - Add \$300 to list, per item

## 3. OPTIONS

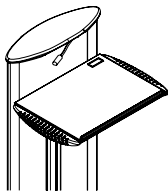

Code	Price	Description
B	\$240	Light - 6" electric goose neck lamp complete with dimmer switch.
T	\$210	Clock - Liquid Crystal Display clock with front control buttons. The clock is flush-mounted in the top right corner of the crown support. Battery included.
PS	\$110	Power Strip - The PowerStrip has 6 outlets with a 4' cord. Mounts in the back of the document platform storage area.

## HOW TO ORDER

# OVLW CL BTPS

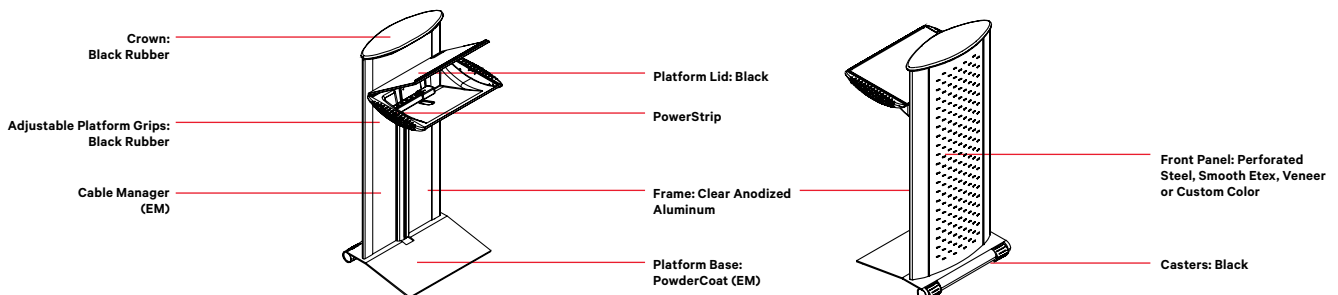

# Wood Veneer EganLectern

The Classic 'Front of House' lectern in your choice of real wood veneers. Two casters on the presenter's side assure the lectern can only be moved by tipping the unit onto the casters (prevents 'run-away' when you lean upon the lectern). Lockable storage and wiring grommets for field set-up of laptops, tablets and microphone. A 17° angled surface with a lip on the bottom is suitable for reference notes.

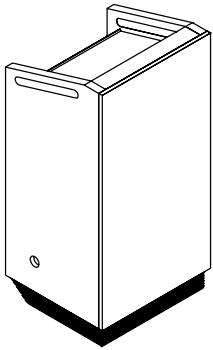

Dimensions	Wood Veneer	
24"w x 48"h x 21"d	\$4,490	Dimensions: Document Shelf: 21 3/4"w x 12"d Upper Storage: 20"w x 8 1/2"h x 17"d Lower Cabinet: 22"w x 22"h x 17"d Lower cabinet with lock to secure electronic equipment Lower cabinet with lock and adjustable shelf

## 1. PRODUCT CODE

Code	Description
LCLF	Wood Veneer Egan Lectern

## 2. FINISH

Light Oak	Medium Oak	Dark Oak	Black Oak	Cherry	Mahogany	Natural Maple	Walnut
LO	MO	DO	BO	CH	MA	MP	WA

Custom Stain available - Add \$300 to list, per item

## 3. OPTIONS



Code	Price	Description
B	\$240	Light - 12" electric goose neck lamp complete with dimmer switch.
T	\$210	Clock - Liquid Crystal Display clock with front control buttons. The clock is flush-mounted in the top right corner of the crown support. Battery included.

## HOW TO ORDER

**LCLF MP BT**

1. Product Code      2. Finish      3. Options

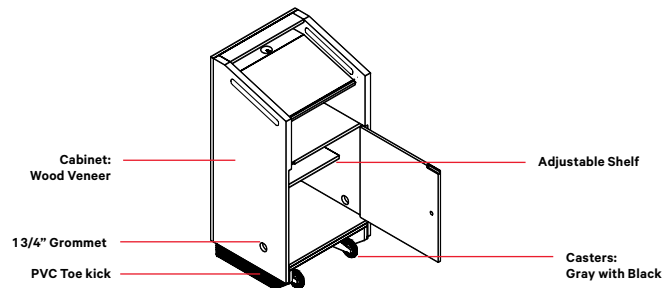

Specify finish followed by options, as shown in sample code below  
Veneer finish only, for Etex finish, see 202 EganLectern

# Wood Veneer ADA

Height-adjustable, real wood veneer ADA Lectern is equipped with a push button electric-lift mechanism that adjusts the working height 34"-44". Inside clearance accommodates wheelchair access and complies with universal design and the Americans with Disabilities Act. Wiring grommets for field setup of laptops, tablets and microphone.

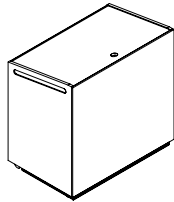

Dimensions	Wood Veneer	
Upper Position: 37 3/4" w x 44" h x 24" d	\$8,560	The electric-lift motor has a one-year warranty 2" locking casters for easy mobility
Lower Position: 37 3/4" w x 34" h x 24" d		
Worksurface: 36 1/2" w x 24" d		
Inside Clearance: 30" w x 24" d		

## 1. PRODUCT CODE

Code	Description
LCLH	Wood Veneer ADA

## 2. FINISH

Light Oak	Medium Oak	Dark Oak	Black Oak	Cherry	Mahogany	Natural Maple	Walnut
LO	MO	DO	BO	CH	MA	MP	WA

Custom Stain available - Add \$300 to list, per item

## 3. OPTIONS

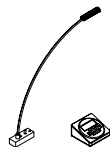

Code	Price	Description
B	\$240	Light - 12" electric goose neck lamp complete with dimmer switch.
T	\$210	Clock/Timer - Liquid Crystal Display clock with front control buttons. The clock is flush-mounted in the top right corner of the crown support. Battery included.

## HOW TO ORDER

**LCLH MP BT**

1. Product Code      2. Finish      3. Options

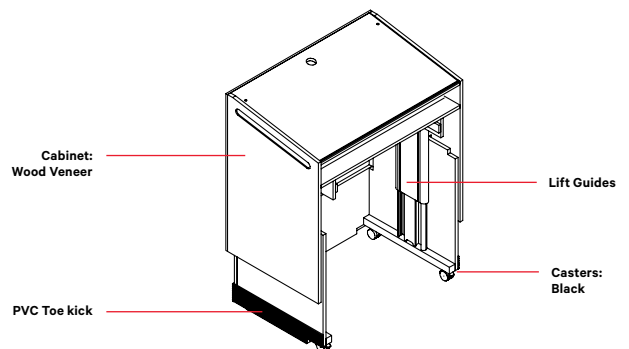

Specify finish followed by options, as shown in sample code below.

# Accessories

Take dry-erase, guaranteed-to-clean EVS™ surface with you everywhere. VersaPalette™ is a handy, lightweight dry-erase surface with a handy thumbhole for an easy grip, handling, and hanging. With a double-sided EVS surface, VersaPalette may also be used as a simple and quick privacy tablescreen, as well as professional temporary signage and wayfinding.

Standard sizes include Letter, Legal, Wide Legal and Tabloid. VersaPalette is not magnet-compatible. Surface warranty is standard 10 years. Product warranty is 30 days. Damage not covered. Product edge is not dry-erase and not covered under warranty. EganINK™ compatible.

### Versa Palette

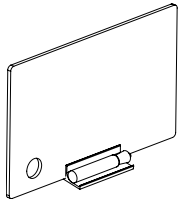

Code	Dimensions	Description	Price
<b>OVPB8X11</b>	8 1/2"w x 11"h	10 pack	\$630
<b>OVPB8X14</b>	8 1/2"w x 14"h	10 pack	\$720
<b>OVPB1114</b>	11"w x 14"h	10 pack	\$800
<b>OVPB1117</b>	11"w x 17"h	10 pack	\$870

### VersaPalette Stand

VersaPalette Stand is designed to hold and display your VersaPalette (of any standard size). Use as simple, quick privacy tablescreen, name placard, or temporary signage and wayfinding. Clear Anodized (CA) aluminum finish with a non-skid base. Integrated Marker Tray. Sold in sets of five (5).

Code	Dimensions	Price
<b>OVPS</b>	4 1/2"w stand for VersaPalette. 5-pack.	\$ 290

### HOW TO ORDER

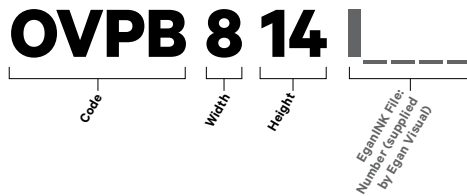

### WHAT'S IN THE BOX

- Ten (10) Versa Palette Bundle
- One (1) Versa Palette Stand
- Two (2) assorted color Dry-Erase Markers
- One (1) EganCloth

### NOTES

- Sizes cannot be mixed to make a 10-pack
- Custom sizes larger than Tabloid may be available. Call Customer Service to inquire
- Custom shapes are available subject to spot quotation of price, MOQ, and lead time.
- Custom hole location is available subject to spot quotation of price, MOQ, and lead time
- Volume discounting available. Call Customer Service to inquire
- VersaPalette is available in EVS only.
- Standard edge color is light gray. Other edge colors are available under Custom Response program



# Trays

## EganAero Marker Tray

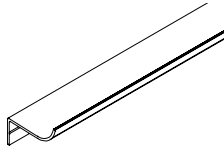

A sleek 1" marker tray designed to complement the minimalist design of the EganAero family of products. EganAero tray is offered with an adhesive mount.

Code	Description	Price
<b>ACEAT12</b>	EganAero Marker Tray. 12"w. 1"d. Ships with two (2) assorted color Dry-Erase markers and one (1) EganCloth.	\$90
<b>ACEAT24</b>	EganAero Marker Tray. 24"w. 1"d. Ships with four (4) assorted color Dry-Erase markers and one (1) EganCloth.	\$120
<b>ACEAT12-12</b>	EganAero Marker Tray. 12"w. 1"d. 12-pack. Ships with twenty-four (24) assorted color Dry-Erase markers and twelve (12) EganCloths.	\$620
<b>ACEAT24-12</b>	EganAero Marker Tray. 24"w. 1"d. 12-pack. Ships with forty-eight (48) assorted color Dry-Erase markers and twelve (12) EganCloths.	\$940

## Egan ONE Tray

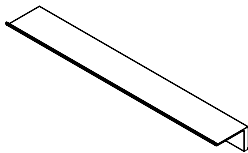

The Egan ONE tray is available with an adhesive mount, for non magnetic surfaces, or a neo-magnet mount, for use with all magnetic surfaces. The 2" deep design accommodates 2 rows of markers and provides an attachment point for the new Egan Cloth.

Code	Description	Dimensions	Price
<b>ACEOT12M</b>	Magnetic Mount	12"w x 1-3/8"h x 2"d	\$150
<b>ACEOT12A</b>	Adhesive Mount	12"w x 1-3/8"h x 2"d	\$150
<b>ACEOT24M</b>	Magnetic Mount	24"w x 1-3/8"h x 2"d	\$180
<b>ACEOT24A</b>	Adhesive Mount	24"w x 1-3/8"h x 2"d	\$180
<b>ACEOT36M</b>	Magnetic Mount	36"w x 1-3/8"h x 2"d	\$200
<b>ACEOT36A</b>	Adhesive Mount	36"w x 1-3/8"h x 2"d	\$200
<b>ACEOT48M</b>	Magnetic Mount	48"w x 1-3/8"h x 2"d	\$220
<b>ACEOT48A</b>	Adhesive Mount	48"w x 1-3/8"h x 2"d	\$220
<b>ACEOT60M</b>	Magnetic Mount	60"w x 1-3/8"h x 2"d	\$260
<b>ACEOT60A</b>	Adhesive Mount	60"w x 1-3/8"h x 2"d	\$260
<b>ACEOT72M</b>	Magnetic Mount	72"w x 1-3/8"h x 2"d	\$270
<b>ACEOT72A</b>	Adhesive Mount	72"w x 1-3/8"h x 2"d	\$270
<b>ACEOT77M</b>	Magnetic Mount	77"w x 1-3/8"h x 2"d	\$280
<b>ACEOT77A</b>	Adhesive Mount	77"w x 1-3/8"h x 2"d	\$280
<b>ACEOT82M</b>	Magnetic Mount	82"w x 1-3/8"h x 2"d	\$290
<b>ACEOT82A</b>	Adhesive Mount	82"w x 1-3/8"h x 2"d	\$290
<b>ACEOT96M</b>	Magnetic Mount	96"w x 1-3/8"h x 2"d	\$320
<b>ACEOT96A</b>	Adhesive Mount	96"w x 1-3/8"h x 2"d	\$320
<b>ACEOT120M</b>	Magnetic Mount	120"w x 1-3/8"h x 2"d	\$360
<b>ACEOT120A</b>	Adhesive Mount	120"w x 1-3/8"h x 2"d	\$360

Custom sizes available

Tray can be mounted through an Adhesive or NeoMagnet mount.

Ships with 2 markers and the EganCloth

# Dry-Erase Accessories

A whiteboard is not just a whiteboard when you combine the dust-free whiteboarding materials listed below. Egan's EVS™ surface, Dry-Erase Markers and EganCloth™ provide a guaranteed-to-clean dry-erase solution.

## Dry-Erase Markers

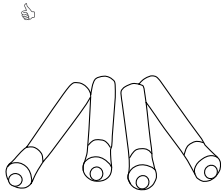

High quality Dry-Erase markers. Assorted colors. One dozen (12).

Code	Description	Price
<b>ACDZ</b>	Assorted color Dry-Erase Markers. Three (3) of each color.	\$50
<b>ACDZGR</b>	Green Dry-Erase Markers.	\$50
<b>ACDZRE</b>	Red Dry-Erase Markers.	\$50
<b>ACDZBLUE</b>	Blue Dry-Erase Markers.	\$50
<b>ACDZBL</b>	Black Dry-Erase Markers.	\$50
<b>ACDZRB</b>	Six (6) Red + six (6) Black Dry-Erase Markers.	\$50

## EganCloth (magnetic mount)

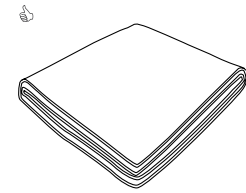

Attracts dry-erase dust like a magnet. No need for special cleaning solutions. Easy to use and clean. Traps dust and grime. Hypo-allergenic and non-abrasive. Integrated neo-magnet that is compatible with all magnetic surfaces. EganCloth is a reusable product. Machine or hand washable. Do not wash with other materials.

Code	Description	Price
<b>EVEC12M</b>	EganCloth (12" x 8") 12-pack	\$100
<b>EVEC24M</b>	EganCloth (12" x 8") 24-pack	\$180

## Egan NeoMagnet



Code	Description	Price
<b>ACEAMAG4</b>	Rare-Earth Magnet. 7/8" diameter. 9/16"d. Box of four (4). Assorted color.	\$130

## EganMount



The EganMount is a 7/8" x 7/8" steel plate with an adhesive back, which will provide a mounting location for the new Egan Cloth. The EganMount can be installed on boards, walls, and is available in a 10 pack.

Code	Description	Price
<b>ACEM10</b>	EganMount 7/8"x7/8" self adhesive metal logo designed to accept the new magnetic EganCloth on non magnetic surfaces 10-pack	\$110

# Grips & Tearbars

## EganSystem Track Mount - Friction Grip

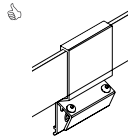

Code	Description	Price
<b>ESFG6</b>	1 1/2"w and holds single flipchart sheets. Available finishes are EganMetallic (EM), Putty (PY), and Charcoal (CL). 6 pack	\$170

- Designed for use with EganSystem 202 Upper Track
- For Custom Color - Please contact sales for a quote.

## EganSystem Track Mount - Variable Tension Grip

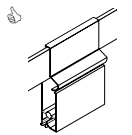

Code	Length	Description	Price
<b>ESVS</b>	3"	Holds paper or Boards up to 1/4" thick. Finishes: EganMetallic (EM), Putty (PY), and Charcoal (CL).	\$80
<b>ESVL</b>	10"		\$100

- Designed for use with EganSystem 202 Upper Track
- For Custom Color - Please contact sales for a quote.

## EganGrip



Display flipchart sheets and more by simply pushing paper up into the gravity-fed roller. To remove sheet, simply curl up and out. Standard finish is brushed Clear Anodized (CA) aluminum.

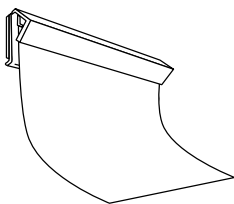

Code	Mount Options					Size
	Magnetic (M)	Adhesive (A)	Plate (P)	Top (T)	System (S)	
<b>G_21.5</b>	\$90	\$90	\$90	\$140	\$150	21 1/2"
<b>G_33.5</b>	\$110	\$110	\$110	\$160	\$170	33 1/2"
<b>G_45.5</b>	\$130	\$130	\$130	\$180	\$190	45 1/2"
<b>G_57.5</b>	\$140	\$140	\$140	\$190	\$200	57 1/2"
<b>G_69.5</b>	\$170	\$170	\$170	\$220	\$230	69 1/2"
<b>G_93.5</b>	\$200	\$200	\$200	\$250	\$260	93 1/2"

- For Custom Color - Please contact sales for a quote.

## Flipcharts, box of 5

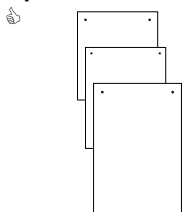

Code	Description	Price
<b>ACFL20225</b>	20"w x 22 1/2"h for 48" x 32" cabinets	\$170
<b>ACFL20305</b>	20"w x 30"h for all other cabinets	\$180
<b>ACFL27345</b>	27"w x 33"h for Flipchart Assembly (EETBFC)	\$260

## Fixed Tearbars



Code	Description	Price
<b>ACTBAR</b>	27"w for Flipchart Assembly (EETBFC, EMTBFC)	\$110
<b>ACCBAR</b>	20"w for Flipchart Assembly for EganCabinets (inside door) (CEWR, CARW, CEWB, CABW, CEWT, CATW, CAPX, CEXB, CABX, and CE2)	\$110

## Adjustable Flipchart Holder & Tearbar, Magnetic Mount



Code	Description	Price
<b>ACTSTBMG</b>	28"w x 2 1/2"h	\$300

# Mount Brackets

## Mount Brackets

Code	Description	Price
ACWALMB20	20"w Standard Mount Bracket. For 2436 Presentation Boxcore, Tack Boxcore 3/4" frame and aluminum framed markerboards.	\$40
ACWALMB32	32"w Standard Mount Bracket. For 4832 Presentation Boxcore, Tack Boxcore 3/4" frame and aluminum framed markerboards.	\$40
ACWALMB36	36"w Standard Mount Bracket. For 4848 Boards, Presentation Boxcore, Tack Boxcore 3/4" frame and 4848, 6048,7248 aluminum framed markerboards.	\$40
ACWALMB45	45"w Standard Mount Bracket. For 72" Cabinets, and 9648 aluminum framed markerboards.	\$40
ACWALMB60	60"w Standard Mount Bracket. For 7248, Presentation Boxcore, Tack Boxcore 3/4" frame.	\$40

Code	Description	Price
ACWALMB-Z36	36"w Z-Bracket. For 4848, 7248, 6048 Boards, Dimension Stele, Tackable Wings	\$40
ACWALMB-Z45	45"w Z-Bracket. For 6048 Boards, Dimension Stele, Tackable Wings	\$40
ACWALMB-Z60	60"w Z-Bracket. For 7248 Boards, Dimension Stele, Tackable Wings	\$40
ACWALMB-Z72	72"w Z-Bracket. For 9648 Boards, Dimension Stele, Tackable Wings	\$40
ACWALMMB94	94"w Standard Mount Bracket. For 94" multiple horizontal EganMosaic board installations.	\$70

Code	Description	Price
ACWALDIM20	20"w Dimension Cleat. For 2436 Dimension Stele™ Boxcore™ boards and Dimension Tack Boxcore boards with 1-1/8" frame.	\$40
ACWALDIM32	32"w Dimension Cleat. For 4832 Dimension Stele Boxcore Boards and Dimension Tack Boxcore boards with 1-1/8" frame.	\$40
ACWALDIM36	36"w Dimension Cleat. For 4848 Dimension Stele Boxcore and Dimension Tack Boxcore boards with 1-1/8" frame.	\$40
ACWALDIM45	45"w Dimension Cleat. For 6048 Dimension Stele Boxcore and Dimension Tack Boxcore boards with 1-1/8" frame.	\$40
ACWALDIM60	60"w Dimension Cleat. For 7248, 7748 Dimension Stele Boxcore Boards and Dimension Tack Boxcore boards with 1-1/8" frame.	\$40

Code	Description	Price
ACWALWFMB20	20"w Solid Wood Bracket. For 2436 Wood Frame Boards.	\$40
ACWALWFMB28	28"w Solid Wood Bracket. For 4832 and 3648 Wood Frame Boards.	\$40
ACWALWFMB48	48"w Solid Wood Bracket. For 48"w, 60"w, 72"w, 96"w Wood Frame Boards.	\$40
ACWALWFMB72	72"w Solid Wood Bracket. For 9648 Wood Frame Boards.	\$40

Code	Description	Price
ACWAL21	21" Cabinet Wallmount Bracket. For 24" Cabinets.	\$40
ACWAL32	32" Cabinet Wallmount Bracket. For 32" and 48" Cabinets.	\$40
ACWAL64	64" Cabinet Wallmount Bracket. For 72" Cabinets.	\$40

# Egan Programs & Services: Overview



\*QuickShip

## QuickShip Program

**QuickShip** - Egan Visual's Quickship Program includes a select range of standard size whiteboards, glass boards, mobile boards and accessories available to ship within 5 days from purchase order clearing credit. Delivery subject to receipt of written order and inventory levels at time of order. For critical orders please confirm by calling **1-800-263-2387**.



Small Parcel  
Eligible

## Egan Freight Program

Per our tiered freight program, orders will have freight charges added to invoice based on order list total. Product with the small parcel thumbs up qualified for our small parcel freight program. Pending quantities ordered. Egan's freight program provides confidence that you can easily quote and will always know the maximum freight charge.



## GREENGUARD Certification

Egan promotes global sustainability, environmental health, and safety. Our products have low chemical emissions, preserving the quality of the air in which the products are used. GREENGUARD conducts strict chemical emissions tests, and certifies products that meet healthy interior standards.

Download your copy of Egan product GREENGUARD Certificates at [www.egan.com](http://www.egan.com).



## EcoTack/PET

EcoTack is Polyethylene Terephthalate (PET). The tackable infill material is an adaptable acoustical panel made from 100% polyester - approximately 50% is recycled water bottles. EcoTack features a 3/8" deep tackable panel mounted proud on the board.



## Egan Fabric Program

Egan offers a range of Maharam fabric options that can be specified on all Tackable and Sound Ideas products. All available fabrics have been factory tested to ensure it delivers upon the quality and performance that Egan demands of its products. For more information on the Egan fabrics available and for more information on custom fabric options, see page 96 or visit [egan.com](http://egan.com).

Contact Maharam directly at **1-800-645-3943** or visit [www.maharam.com](http://www.maharam.com) for samples or memos for presentation. For your convenience, digital representations are available online at [www.egan.com](http://www.egan.com).

## Flammability

Maharam textiles meet all appropriate flammability requirements (further details available, please contact Maharam):

- California Bulletin #117
- Compatible with California Bulletin #133
- Tunnel Test surface ratings
- Class I UFAC



## Egan Infinite Color Palette

Choose from over 1,000 standard colors at no additional cost. The Infinite Color Program is available on all Egan Glass products - EganAero and GlassWrite. The color program includes Egan Infinite Palette and Pantone colors (uncoated and coated). To view the full range of colors, visit [pantone.com](http://pantone.com) or [egan.com](http://egan.com).



## Custom Stain

Egan offers 8 stain options but have the resources in house to match or create a custom stain based on your design. For an additional upcharge of \$300/ product Egan will work with you to give you the stain you need.



## EganINK

Enhance Egan products by specifying EganINK. Print on any of the following Egan surfaces: GlassWrite, EganAero, EVS, and Fabric. EganINK is perfect for injecting branding, custom graphics, signage or artwork into your space. To learn more about Egan's high quality, large format graphic printing, see page 94.



## Custom Response

As a manufacturer, Egan has a wide range of capabilities and resources available to provide a product that is tailored to a customer's specific needs. From simple customizations like logo designs and sizes adjustments to more complex configurations such as new product design, we will work with you at every step of the way. For more information on how to engage Egan and to learn more about our process.

# Custom Color & Color Matching



Having a hard time finding that perfect color? The Infinite Color Program or Custom Color Matching program may be just what you need.

We strive to provide the most accurate representation of your selected color possible. Glass's natural material content may influence the representation of your color when viewed through Egan glass. Egan recommends requesting a clear glass sample to place over the top of your color swatch to provide a more accurate representation of your color's appearance when applied to the back of a GlassWrite markerboard.

### There are three easy ways to choose a color

1. Choose a color from the Infinite Color Program, which will include Pantone colors: [pantone.com](https://www.pantone.com)
2. Specify a color from an industry or commercial standard fan deck (RAL, Pantone, Benjamin Moore, Sherwin-Williams, etc.)

There is a standard upcharge unless indicated otherwise.

The Custom Color program is limited to color matches that do not have speckles, patterns or any metallic content. Egan uses polymer coatings which may be specified in custom colors. These polymer coatings may add texture or sheen options that will affect the appearance of your chosen finish. Egan will match the color specified as closely as our formulating process allows. Please note that color gloss cannot be matched. There is a standard upcharge unless indicated otherwise. Samples are not provided for approval unless requested, additional charges may apply. Finishes outside of these parameters will be addressed on a sample by sample basis and additional charges may be applicable.

# Custom Stain



Egan encourages custom stain applications. Our finishing system is automated and ensures that the proper amount of stain and lacquer is sprayed on each product. However, as wood is a natural product, each log will vary in color and appearance. Egan's skilled carpenters match doors and components to enhance the natural and variable beauty of real wood.

All veneers are small heart, center book matched and finished in a fast curing two component lacquer which provides a durable, open-grain silk-matte finish. Veneer is 1/64" - 1/32" thick. Occasional cleaning with any household furniture polish will maintain this finish like new for many years. Customers are responsible for the suitability of the final product. Many modern veneer selections are available through our Custom Response program.

### Ordering Custom Stain

1. Provide sample species (Oak, Cherry, Mahogany, Maple and Walnut) with stain applied. Where possible please provide details of stain manufacture, product number, and application details so our crafts people can reproduce the custom stain as accurately as possible within Egan's normal manufacturing process.
2. Egan will produce a sample for review.
3. Egan will require signed approvals with PO. Natural variations are to be expected and are not Egan's responsibility.

### Unfinished Wood Products

Unfinished Wood Products may be ordered:

- By specifying wood species required and
- By tagging it "Ship to customer unfinished."

Preparing a product for custom staining requires additional steps to be taken, at no additional cost. Any complaint regarding the quality of a unit must be registered prior to any finish work being performed.

Note: Presentation Cabinets with tackable fabric panel on the inside of each door on any unfinished unit is supplied with paper wrapped around it to protect the fabric from stain during the finishing process. The paper should be carefully removed by cutting around the perimeter with an appropriate blade.

# EganINK - High Graphic Printing

Sometimes, creative environments need visual interest or structure to inspire and complete thinking. Bold or understated, EganINK complements and sets the mood, whatever your mood may be – KPI templates, care boards, logos, wayfinding, signage, or high-resolution art. EganINK bespoke graphics may be specified on a wide range of Egan products, whether it be stock art or COA. This is where the ability to customize and introduce your own design to our communication tools is useful.

EganINK is an innovative ink system provides high resolution multi-color application of letters/lines/graphics. EganINK gives you the flexibility to uniquely communicate your message, showcase your brand, and express your ideas. With infinite possibilities for customization with lines, grids, dots, letters, logos, graphics and full-color art, you can create one-of-a-kind charts and collaboration boards that truly inspire. The design intent of EganINK is that it will represent most artwork and logos faithfully at a normal viewing distance, allowing you to have a functional workspace that is in harmony with your corporate identity and the design of the room. GlassWrite and EVS products may be printed on. EganINK has a limited 1 year warranty.

EganINK has been set up to be easily priced,

1. For Prints of 1sqft or less apply a \$300 upcharge
2. For Prints exceeding 1sqft please reach out to sales for a quote



TEMPLATES & CHARTS



BRANDING



ARTWORK & PHOTOGRAPHY

## Custom Response Program



The Custom Response Program is designed to encourage specialized product development. Our manufacturing systems provide for variations and custom solutions. Working with initial direction from designers and clients, Egan will research and develop solutions that work within the Egan manufacturing process. This makes the program ideal for those clients who require a single run of a substantial number of products and/or where there is an ongoing need. Opportunities for complete product design where volume is available are also encouraged.

Our CAD specialists understand high-quality cabinetry and can quickly evaluate Custom Response Program requests. Contact your local Egan Representative with your product needs. Pricing and delivery is based on individual requirements.

### Example #1

**Original product:** V-Series Mobile

**Custom product:** Customer's Own Panel with customer's slat wall installed 30" from the floor to match desk height.

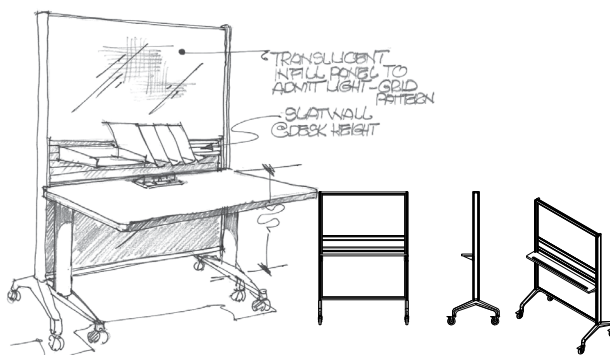

### Example #2

**Original product:** 202 Mobile Instruction Center

**Custom product:** University Lecture Command Console 42" wide, with monitor and room control touchscreen and AV racking. A popular variation of the S2IM.

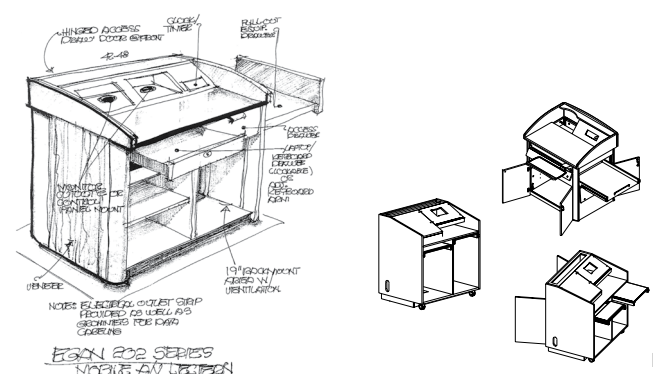

# Egan Fabric Program

Egan has tested compatible fabrics with Guilford of Maine (GOM) and Maharam Fabrics. Egan factory tests and approves tackable and acoustical textile designs in two grades. Guilford of Maine and Maharam's M-Series program (excluding Messenger pattern fabric) are available on most Egan Products as an aesthetic option - the cost is added to the total cost of the specified product and applicable options.

## Need Fabric Samples

Egan stocks samples for:

- Egan Fabric
- Maharam Fabric Program Card
- GOM Fabric Program Card

Contact Guilford of Maine directly at **1-800-544-0200** or visit [www.guilfordofmaine.com](http://www.guilfordofmaine.com) for memo samples.

Contact Maharam directly at **1-800-645-3943** or visit [www.maharam.com](http://www.maharam.com) for memo samples.

For your convenience, digital representations are available online at [www.egan.com](http://www.egan.com).

## maharam

To place an order please specify:

1. The Maharam fabric number, including color, dye lot (if applicable), name. For example: Maharam Medium Pool 463490-040
2. Based on this information, you can build the Egan product code, including finish and option codes, followed by the textile code as shown below:

**CE2 A 6048 MP FL 463490-040**



## Guilford of Maine

To place an order please specify:

1. The Guilford of Maine fabric number, including color, dye lot (if applicable), name. For example: GOM, FR701 White 2100-224
2. Based on this information, you can build the Egan product code, including finish and option codes, followed by the textile code as shown below:

**SIAPS3 1 V 48 48 S R 2100-224**



### Customer's Own Material (COM)

All Egan tackable components may be ordered with EganFabric Program textiles or with customer-supplied fabrics. Customer's Own Material (COM) handling is priced as \$150 list per order. The cost of textile and delivery are additional costs that are not included in Egan pricing. It is the customer's responsibility to determine if the fabric is appropriate for the application specified and that it meets applicable codes and regulations.

Egan reserves the right to reject fabrics that, in our opinion, would create unsatisfactory results on the intended application with our normal manufacturing methods.

If it is established that the textile selected will compromise the quality or integrity of Egan products, customers are contacted to discuss these concerns.

Egan does not accept responsibility for unsatisfactory results, overall appearance, fabric defects, flammability, normal durability, color fastness or any other quality issue after installation, beyond normal Egan quality standards.

At Egan Visual, we strive to craft superior results. Visit [www.egan.com](http://www.egan.com) for further details on COM and Egan Fabric Program.

### COM Specification for Tackable Panels

1. Customer/Company Name
2. Contact name, phone number and email address
3. Egan product code, correctly specified
4. Fabric sample - indicate face side and pattern direction  
Supply a sample securely fastened to order showing pattern direction.
5. Customer purchase order with COM correctly indicated
6. Fabric manufacturer, fabric name, color, code and dye lot
7. Fabric requirements fully specified, including (but not limited to) horizontal/vertical direction, pattern matching, railroading, pattern repeats, reversibility.

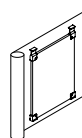

Cut across the roll (known as 'railroading')

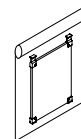

Cut up the roll (typical or normal direction)

8. Visit [www.egan.com](http://www.egan.com) for COM Product Yardage Requirements.
9. All COM must be sent prepaid to:  
**Egan Visual**  
**Attention: COM Receiver**  
**300 Hanlan Road**  
**Vaughan, ON L4L 3P6 Canada**
10. Label instructions securely applied to COM.



# Cleaning Instructions

## EVS: Egan Versa Surface

The high-quality, dry-erase surface EVS cleans so effectively, it even withstands the use of permanent markers.

1. Use EganCloth to trap dry erase dust in the micro-fibers and maintain a clean surface.
2. Remove all dry-erase markings from surface with a clean EganCloth before applying spray glass cleaner such as Windex. Regular cleaning with a recommended spray glass cleaner and an EganCloth will prevent dirt and film buildup, and remove residue, that can impede dry-erase performance.
3. Use isopropyl rubbing alcohol 90% to remove stubborn marks and residue.

\*Egan recommends solvent based Dry-Erase Markers ( BIC Great Erase Bold) or comparable marker.

## GlassWrite

Regularly removing ink, dirt, stains, or grease from fingerprints is the best way to preserve the quality of your glassboard. Take care of your GlassWrite by following the instructions:

1. Typical day to day maintenance should not require any more than cleaning with Windex, or an ammonia base glass cleaner. Care should be taken to avoid glass cleaners with detergents that will leave a residue, which will affect the dry erase characteristics of Egan GlassWrite boards.
2. Wipe the glass until dry using a clean EganCloth or paper towel to remove streaks that may have formed.
3. If any contaminants remain on the glass, 90% isopropyl alcohol can be used to remove it. This works well with sticky or gluey materials and permanent markers.

## Fabrics

Maintain the quality and longevity of your fabric board or sound panel by carefully removing dust, dirt, stains and other forms of debris that accumulate overtime.

1. UPHOLSTERY VACUUM OR BRUSH: Lightly brush with a soft brush, or lightly vacuum with an upholstery attachment. Vacuuming will minimize the accumulation of dirt and dust. Do not use high suction commercial vacuum as they may cause damage.
2. A FABRIC FRIENDLY CARPET CLEANER: Most soiled areas can be cleaned using a damp cloth, if there is a stubborn stain, please use a commercially available upholstery or carpet cleaner that can be used on polyester fabric.

Note: If possible, test the selected cleaning agent on a non-visible area of the panel before attempting to clean the soiled area to assure best outcome.

## Porcelain

Using an EganCloth with a cleaner - such as warm soapy water, window cleaner or isopropyl rubbing alcohol 90% - is enough to keep a the Porcelain surface clean, if used every week. Dry erase markings and ink stains left on the porcelain surface for weeks or months may require a stronger cleaning solvent to fully remove old writing (isopropyl rubbing alcohol 90% may remove these stains). Remove any cleaning solution residue from the surface with a dry, clean EganCloth to prevent any reactions between solvent residues and inks in dry erase markers. Do not use wax-based cleaners as they will leave a residue on the surface.

\*Egan recommends solvent based Dry-Erase Markers ( BIC Great Erase Bold) or comparable marker.

# Purchase Order Requirements for Expedited Order Processing

Egan Visual strives to offer quality products at a great price. We value your decision to place your orders with us. In order to promptly acknowledge your orders we need you to supply sufficient and correct information. Please review the guide below.

Sample Purchase Order			FL
<b>Order Date:</b>			
<b>Purchase Order #</b>			
<b>Vendor:</b> EGAN VISUAL, 300 HANLAN RD., WOODBIDGE, ON, L4L 3P6	<b>Billing:</b> (Company Name) (Address) (City, State, ZIP)	<b>Delivery:</b> (Company Name) (Address) (City, State, ZIP) <b>(F.I.N.)</b>	
<b>Egan Acct. #</b>	<b>Egan Acct. Payment Terms:</b>		
<b>Correct Product Information:</b> (Quantity, Item code, Option code, Mounting Option code as applicable)			
<b>Complete:</b> (Product description including wood species, color or fabric numbers as applicable)			
<b>Maharam Tackable Fabric:</b> (Fabric grade [A, B, C], Style #, Name, Color, Description, Upcharge)	<b>Custom Color:</b> (Provide matching system type)	<b>Custom Stain:</b> (Supply sample with purchase order. Include stain manufacturer, stain number or name and base of species)	
<b>Customer's Own Material:</b> (Fabric manufacturer, fabric name, color, code and dye lot, fabric requirements fully specified)	<b>VersaJot Electronic File:</b> (Specified as per Price and Specification Guide)	<b>Custom Logo:</b> (Appropriate electronic artwork, specific color details)	
<b>Accurate Unit Price + Extended Price + Total Price</b>			
<b>Discount Taken:</b>	<b>Delivery Date:</b>		
		<b>Signature:</b>	

**Complete P.O. must include...**

- P.O. number
- Billing address
- Delivery address
- Delivery Contact Information
- **Note:** A P.O. Box cannot be accepted as a delivery address.

**Don't forget...**

- F.I.N. for USA delivery addresses only.

**Do you have...**

Correct and complete product information, including special colors, stains, and fabric options.

**Note:**  
Look for "How To Order This Product" at the bottom of each page.

**Include...**

Egan quote reference if applicable.

**Remember...**

Let us know when you need your order and if we can deliver before your expected delivery date.

**Double-Check...**

Price and discount structure must be correct to ensure immediate processing of your order.

**Email confirmations...**

Enter buyer's contact name and contact email address.

# Egan Standard Terms & Conditions

## Commercial Terms

### Overall

Egan Visual Standard Terms & Conditions are subject to change without notice. See [www.egan.com](http://www.egan.com) for currently prevailing terms. All specifications, pricing, and other information is believed to be accurate at the time of publication (E&OE) but is subject to change without notice. Prices herein are valid in the United States only and are stated in USD. Possession of this document does not constitute an offer to sell.

### Cancellations

Orders are considered binding on the Buyer and on Egan, subject to the ICC Force Majeure Clause 2003 or the ICC Hardship Clause 2003. If the Buyer wishes to cancel an order, the decision to accept cancellation lies with Egan and will be governed by its ability to conform. A penalty or service fee may be imposed at the discretion of Egan. Once production has begun, neither standard or custom orders are eligible for change or cancellation.

### Change Orders

The Egan Visual 'Order Acknowledgment' is final and binding and any subsequent change is subject to approval at the sole discretion of Egan. Egan Visual reserves the right to increase the acknowledged price, if such a change warrants any extra charge.

### Defects and Shortages

All claims must be reported within the first **TEN (10) days** after delivery of goods. Egan Visual assumes no responsibility for misuse or abuse.

### Returns

Merchandise may not be returned without the prior written consent of Egan Visual. If returned within thirty (30) days, and by agreement, a restocking and repacking charge will be deducted from the credit note in addition to any expense for reconditioning that may be necessary. Return transportation must be prepaid (DDP Buffalo, NY or DDP Vaughan, ON), packed in the original packaging.

## Financial Terms

### Financial Terms

Terms are "prepayment with order" unless otherwise pre-approved, in writing, in advance, by Egan Visual. For such accounts, orders are subject to limit or withdrawal of credit at any time. The approved purchaser will be invoiced for the goods as they are shipped and payment is due thirty (30) days from the date of invoice. Late penalties will be charged on overdue invoices. Invoices are payable in USD funds and do not include taxes or installation. All orders accepted are subject to prices prevailing at time of Order Acknowledgment.

### Quotations

Quotes issued by Egan Visual are valid for ninety (90) days and are for the products and terms specified therein.

### Order Acceptance

Orders are binding only upon acceptance by the executive office of Egan Visual which is confirmed by issuance of an Egan Order Acknowledgment. Orders accepted by Egan Visual shall be subject to the Terms and Conditions set forth in this Acknowledgment and subsequent Invoice, notwithstanding any variance in terms and conditions set forth in the buyer's order forms. Minimum order value is \$100.00 list. Egan Visual appreciates your order and will endeavor to fulfill it as agreed.

### Taxes

Sales Tax, Use Tax, or other State, Provincial, or Federal taxes will be added to the invoice as applicable, and are the responsibility of the Buyer. Buyers claiming exemption (e.g. purchasing for resale) must supply the appropriate tax exemption form with their order. In jurisdictions where Egan Visual is not registered to collect tax, it is the sole responsibility of the Buyer to determine what, if any tax is applicable to the sale and to remit same to the appropriate tax authority.

## Product Terms

### Specification Changes

Specifications published are nominal and believed to be accurate at the time of publication. The right to affect, change, or discontinue models at any time without prior notice remains the right of Egan Visual. This right to change applies to catalog contents, price lists, fabric or finishes, as well as details and dimensions.

## Warranty

Each product carries a limited, "Return to Factory" warranty. See the full "Standard Warranty" in the Price & Specification Guide or at [www.egan.com](http://www.egan.com)

## Logistics Terms

### Freight Terms

Orders are shipped FOB Factory (INCOTERMS 2010). Freight is prepaid and added to the buyer's Invoice. The responsibility of Egan Visual ceases when it turns the shipment over to the carrier.

### Free Freight Program

Egan offers a program under which freight may be prepaid in full or subsidized by Egan. See "Freight Program" for current details.

### Drop Shipments

Drop Shipments can be arranged. Egan does not apply a fee but Accessorial Charges may apply. Contact Customer Service.

### Accessorial Charges

Accessorial Charges will be invoiced at cost and pre-quoted on request. This includes but is not limited to: deliver to limited access site (mines, prisons, military, schools, and hospitals), blanket wrapped, inside deliveries, special charges for high density urban areas, will calls, 'call before' requirements and special delivery or inside delivery beyond dock-to-dock delivery

### Packing and Crating Charges

All products are shipped via common carrier, in the best packaging method for the product end order. Crating/bulk packaging will be decided at factory discretion based on various order factors.

### Carrier Selection

In absence of the buyer arranging transport, Egan Visual reserves the right to ship by what is in its opinion the best method.

### Transportation Delay

Egan Visual is not responsible for delay or failure to fulfill an order due to Acts of God, Hardship, or Force Majeure, including but not limited to reasons stated in the standard ICC Force Majeure Clause section 3.

### Storage

If Buyer cannot accept delivery on the shipping date stated on the Order Acknowledgment, Egan Visual reserves the right to arrange storage at the Buyer's risk and expense.

### Freight Damage

All goods are shipped FOB Egan Visual, however, in the event of freight damage we can assist your receiver with the claim. The legal responsibility of Egan Visual ceases when it turns the shipment over to a common carrier. The buyer has the sole obligation of seeking recourse against the carrier. All freight is given to the carrier and signed for in good condition. It is the responsibility of the receiver to sign for the goods in the presence of the carrier and note the condition in which they are received. Freight claims should be filed with the carrier.

Follow these procedures immediately upon receipt of shipment:

1. You must inspect the freight at the time of delivery and note all damages on the Bill of Lading and Delivery Receipt (POD). If there is obvious and severe damage, receiver has a **right to refuse delivery**. Receiver also has a duty to mitigate the loss. For example, you should only refuse affected product.
2. Upon discovery of the damages, the receiver must immediately report the damages to the carrier, asking for immediate inspection and an inspection report.
3. The notification of damages must be followed up in writing by fax or e-mail.
4. Unpack and inspect. Check your contents within **THREE (3) business days**. If the shipment was delivered without noted damage but has CONCEALED DAMAGE, receiver typically has a very limited time to report it to the carrier and request a 'concealed damage inspection'.
5. Tag and keep any packaging in which damaged goods are received in its original condition.
6. Contact Egan Customer Service to initiate a Support Case and make arrangements for replacement product.

# Freight Program & Egan Standard Warranty



## Freight Program

Based on the **order total** summed using the **list price** of the products, the freight costs are invoiced per the following table:

Single shipment total at LIST	Freight Charge*
\$0 - \$4,999	\$279
\$5,000 - \$9,999	\$379

Single shipment total at LIST	Freight Charge*
\$10,000 - \$14,999	\$479
\$15,000 +	\$579
Small Parcel	\$50

\*amount added to invoice

\*excluding Accessorial charges, per Standard Terms

## Egan Standard Warranty

### What is Covered

This Standard Warranty applies to new products purchased from an authorized Egan Visual ("Egan") dealer or reseller. Egan Visual warrants that the products substantially conform to the specifications published by Egan at the time of manufacture of the product, and that the product is free from material defects in materials and workmanship, under normal and reasonable operating conditions, for the Warranty Term as defined below. No other warranties or representations, express or implied, other than contained herein shall apply or be honored by Egan Visual.

### Who is Covered

The "End User" holds this Standard Warranty. The End User is the first party to purchase the new and unused product from an authorized Egan reseller. This Standard Warranty is not transferable to other parties.

### What is Not Covered

EGAN VISUAL MAKES NO IMPLIED WARRANTIES OF FITNESS FOR A PARTICULAR PURPOSE. THESE AND ALL OTHER IMPLIED WARRANTIES ARE SPECIFICALLY DISCLAIMED BY EGAN VISUAL. The warranty as stated in this document is the complete and only warranty upon this product. This Warranty specifically excludes:

- Products that are not purchased by the End User from an authorized reseller
- Products that have been used other than according to the instructions
- Products that have been damaged due to the connection of other equipment
- Products that have not been installed and/or maintained as per the instructions
- Products that have been damaged
- Products that have been modified
- Peripheral products in the package such as brackets and fittings, which are "as is"
- Products and services that are not provided by Egan, including installation, de-installation, and shipping
- Variations in surface materials (e.g. grains, patterns, textures), color variation and colorfastness
- Non Egan-branded products or components which may be purchased from Egan, which are subject to that manufacturer's own warranty.

**IMPORTANT:** READ AND UNDERSTAND ALL INSTALLATION, USE, AND MAINTENANCE INSTRUCTIONS THAT YOU HAVE RECEIVED WITH YOUR NEW EGAN VISUAL PRODUCT. Failure to do so will void all warranty. Before attempting to deviate from our instructions in any way please contact Egan Visual beforehand. If in doubt as to how to install any of our products please contact the Egan Visual dealer you purchased the product from or contact our Customer Service department immediately for help.

**Installation is not covered.** Egan Visual products are designed to be installation-ready, however installation and the installation environment are out of the control of Egan and therefore installation is not warranted by Egan in any circumstance. Egan offers dealers and professional installers free installation support via **1-800-263-2387**.

Conditions after leaving our facility are always beyond the control of Egan Visual. As noted above, **damage is not covered.** This includes but is not limited to damage from use of non-approved detergents, abrasives or other harsh cleaning agents, poor installation, misuse, abuse, neglect, or failure to maintain the product properly. Always be sure to test a cleaning product in an inconspicuous area before cleaning any surface, coating, or finish. For best results on presentation surfaces, always use quality alcohol-based markers; Egan-supplied markers and cloths are recommended. If marker suitability is in question, please call our Customer Service before using the product for the first time. This warranty does not cover damage to writing surface resulting from negligence, abuse or accidents, such as burns, cuts, scratches, scuffs, kinks, or indentations.

## Limitations and exclusions

This program is limited to destinations in the 48 contiguous States, and 10 Canadian Provinces (excludes the Territories YT, NT, NU). This program provides for normal ground transportation. Program eligibility is subject to Egan Standard Terms & Conditions.

## Warranty Term

Your new Egan Visual product has been well-designed and built for many years of enjoyment. All Egan Visual products carry a warranty term of five (5) years from the date of purchase unless otherwise stated here:

EVS® Presentation Surfaces "Guaranteed-to-Clean"	10 years
Porcelain surfaces	10 years
GlassWrite™ and EganAero™ surfaces	10 years
VersaPalette™ products	30 days
EganINK™ (ASTM F793 10a Category I Wallcovering)	1 year
Electric-powered mechanisms	1 year
Electric components (e.g. wiring, charging ports, outlets)	1 year
Lighting components	1 year
Monitor including back light.	90 day
Supplies	None
Installation	None

## Extended Warranty Term

An extended warranty term may be available for purchase. Please call to inquire.

## Consequential or Incidental Damages

EGAN VISUAL WILL NOT BE LIABLE FOR CONSEQUENTIAL OR INCIDENTAL DAMAGES. Any loss, expense, or damage incurred in replacing any suspected defective Egan Visual product will not be reimbursed. The warranty of this product is limited to the replacement or repair of the Egan Visual product itself. Under no circumstances will Egan Visual be responsible for incidental damages, repairs, labor or other costs incurred in removal or return of suspected defective Egan Visual product.

## How to make a Warranty Claim

While the product is still in its original installed state, contact Customer Service to open a case for your product and to have the claim evaluated. If a written Return Authorization has been issued by Egan Visual, the product may be uninstalled and shipped. Shipments that arrive without a valid Return Authorization will not be accepted.

## Warranty Point

This warranty is a "Return to Factory" or "RTF" Warranty. To exercise this warranty, the product must be shipped to Egan DDP Buffalo, NY (INCOTERMS 2010) or DDP Vaughan, ON (INCOTERMS 2010) at the discretion of Egan Visual. Replacement product is made available FOB Buffalo, NY or EXW Vaughan, ON.

## Processing of a Warranty Claim

Your product will be evaluated within a reasonable period of time and at the sole option of Egan Visual and if the claim is approved by Egan it will be repaired, or replaced with refurbished or new product. In the event that the model has been discontinued and warranty stocks have been depleted, Egan, may, at its sole option, replace the Product with a different model with comparable or better performance characteristics. At the sole option of Egan Visual, if repair or replacement is not practicable, Egan will provide a refund or a credit for the affected product.

- ACBUMPER.....49
- ACCBAR .....82
- ACDZ.....81
- ACEAMAG.....81
- ACEAMAGSH.....81
- ACEAT .....81
- ACEM .....84
- ACESR .....14
- ACFL.....82
- ACLINK.....49
- ACSHELF.....49
- ACSCR.....82
- ACTBAR .....82
- ACTSEC.....29
- ACTSECTREM.....29
- ACTSTBMG.....82
- ACWAL.....83
- ARC .....10
- ARCM.....46
- AVBE.....34
- AVBG.....34
- AVBM .....34
- AVBP.....34
- AVBT .....34
- AVBW .....34
- CABW .....41
- CABX.....40
- CAPX.....40
- CARW .....41
- CATW.....41
- CE2.....43
- CEEB.....44
- CEGMB.....44
- CEWB .....41
- CEWR.....41
- CEWT.....41
- CEXB .....40
- DG .....24
- DGR .....24
- DGE .....26
- DGF, DGC.....24
- DGM .....24
- DGMR.....24
- DGMB.....12, 13, 24
- DM.....7
- DMR .....7
- DM\_P .....7
- DMB .....13
- DMI.....7
- DMS.....7
- DT.....7
- DTR.....7
- DTB.....12, 13
- EAB.....12, 13, 22
- EAH.....22
- EETB.....32

- EETBFC.....32
- EMGT .....29
- EMMT.....30
- EMST.....29
- EMTB.....32
- EMTBFC .....32
- EMTSEC.....29
- EMTSECG.....29
- EMTT .....30
- ESFG.....82
- ESGT.....29
- ESMT.....30
- ESOC.....36
- ESSH.....35
- ESST .....29
- ESTR.....29
- ESTT .....30
- ESVL, ESVS .....82
- EVB.....33
- EVEC.....81
- EVPR.....31
- EWHEM .....28
- EWVT.....28, 30
- L .....17
- IW.....20
- KEA.....52
- L .....49
- LCLF .....78
- LCLH .....79
- MDS.....16
- MDTS.....16
- MDTW.....19
- MES.....16
- MEW, MDMW.....16
- MFTE, MFTM.....18
- OVLW .....77
- OVPB, OVPS .....80
- OVO .....76
- PBB.....12
- QB.....35
- S2IM .....75
- S2LF .....74
- S2LH.....76
- S2LS.....69
- SIAPS3.....63, 64
- SIDT .....65
- SIM.....62
- SIW.....62
- SM.....38
- T2LS, T2TM .....70
- T3LS, T3TM .....68
- TLLS, TLTM .....72
- TSA.....55
- TSB.....56
- TSDM .....58
- TSF.....60

- TSG.....57
- TSGB .....56
- TSM.....59
- VBD.....47
- VBM .....47
- VCD.....51
- VCF.....49
- VCT .....49
- VGC.....50
- VGM .....50
- VGM-SS .....50
- VGS.....50
- VJ.....37
- VJCONT .....28
- VJCORNER.....28
- VJEC.....80
- VJRST .....28
- VJTRIM.....28
- VLF .....51
- VLG .....51
- VM.....38
- VP .....72
- VP-CADDY .....28
- VPC .....28
- VPF.....48
- VSD.....51
- VSF .....48
- VST.....48

The following items are discontinued. Egan Visual will continue to support the warranty of these items at the time of sale to the original purchaser and many of these items may still be available as a Special Project. Please contact your Egan Rep or Egan Customer Service for details.

ASCRTSRPST	MDR
CEEAB	MDMB
EBE	MDTB
EBGM	MER
EMSCR	MM
EODK	OCR
EOEX	OM3P, OM4P
EOPC	OMT
ESCTEM	PC-2
ESF	SIAPS
ESR	SIHIPA
ESW	SIHBS
ESZP	SIO
EVCC	SIT
EVPK	SIWPS
EVVE	TP
GET	VJCC
GWTF	VPM
HAD	
JET	
IFP	
MDB	

**EGAN**

**Egan Visual**

1-800-263-2387

customerservice@egan.com

Mon-Fri: 8:00am - 4:30pm EST

**www.egan.com**

**BUILT**

**TO INSPIRE**

July 13, 2021 - Printed in Canada. © Egan Visual 2021. All Rights Reserved. All other product names are trademarks of their respective owners. Samples available from Egan Customer Service. Specifications are subject to change without notice. E&OE.